

Summary

WIRING.....	2
Connector.....	3
KILL SWITCH.....	4
Setup Mode.....	5
Troubleshooting WiFi connection.....	6
Ignition Timing.....	10
Pickup Type.....	11
Pickup voltage.....	12
VR Pickup.....	13
Hall Sensor.....	14
Points.....	17
Pickup Position.....	18
Strokes.....	20
Shaft.....	21
Advance Timing.....	22
Dwell.....	23
Select curve.....	24
Security.....	25
Shifter.....	26
Read.....	28
Dump.....	29
Modification.....	30
Add points.....	31
Clear points.....	32
Clear Timing.....	33
Clear All.....	34
Factory Restore.....	35
Advanced settings.....	36
Advance at kick start.....	36
AutoSpark.....	37
Bypass.....	38
Console.....	39
Troubleshooting.....	41
Running Mode.....	42
Update firmware.....	43
Appendix 1.....	45
Appendix 2.....	47
Appendix 3.....	48
Appendix 4.....	51

WIRING

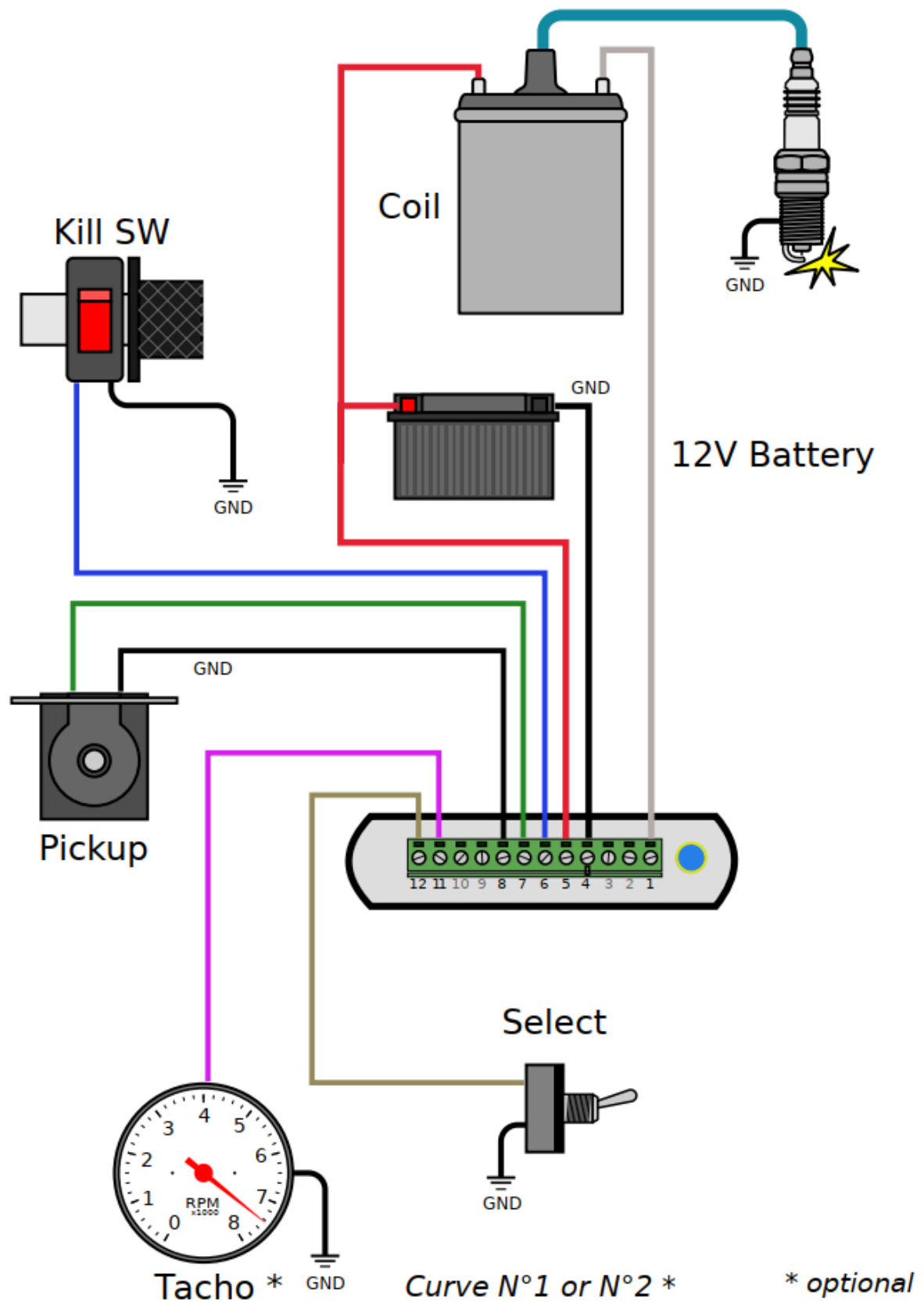

Connector



1	output	To ignition coil
2	output	<i>unused</i> (connected To ignition coil)
3	input	<i>unused</i> (connected to Ground)
4	input	Ground frame (=minus from battery)
5	input	+12Vdc from battery
6	input	Kill switch
7	input	Analog Pickup
8	input	Pickup Ground or Hall Sensor Ground
9	input	Digital Hall Effect Sensor *
10	input	Security or Shifter *
11	output	Tachometer *
12	input	Curve Selection *

** Options*

KILL SWITCH

The ignition uses the Kill switch input as a selector between 2 functions:

- Setup

- Stop engine

Setup Mode

1) Turn the **Kill Switch ON** (*connector pin 6 connected to ground*) **PRIOR** to power on the ignition box.

2) **Power on** the ignition box with a 6 to 12v battery.

**Warning: The Power and Ground connections MUST BE SECURE.
A power outage during the setup process may cause the ignition box to brick !**

When the ignition box detects that the kill switch is already grounded, it turns into SETUP Mode.

3) The **Led blinks 5 times** meaning grounded Kill switch has been detected.

Kill wire can be disconnected from the ground.

Then wait for the WiFi server to start,

then **blinks 5 times** again meaning "*Wifi Ready*" and finally flashes once every 5 seconds.

4) The ignition box starts a **WiFi AP (Access Point)**

5) On your phone, laptop, PC, whatever, go to the **Wifi setting** and search for a new SSID called "**Transmic_ign**"

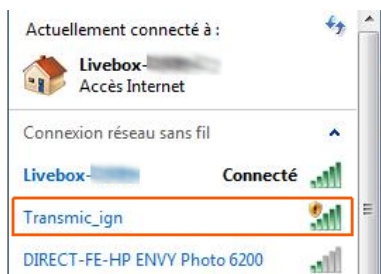

6) **Connect** to it. If a Password is required, it's "**password**"

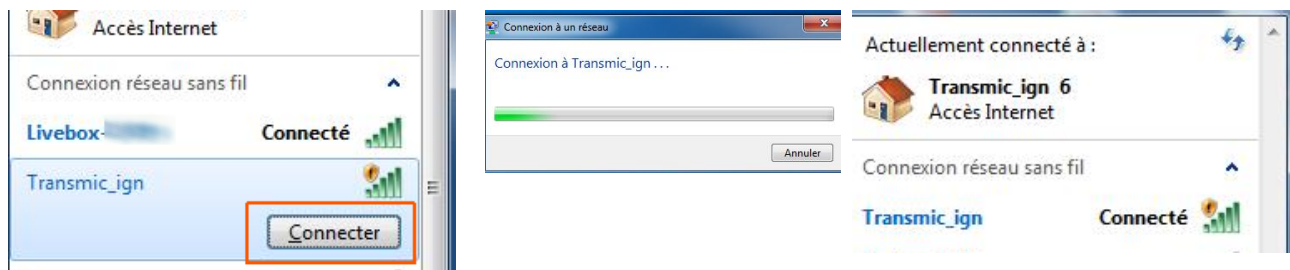

8) Once your device is connected to the AP, open up a **browser** and head over to <http://192.168.4.1/setup> (**http not https !**)

9) Once connected your browser should display:

TRANSMIC.FR

TCI V14R0C0

You are now connected
to your ignition box.

Options: 5
Serial: 2405 ©

[configuration](#)

Documentation:
<https://transmic.fr/tci14>

10) If not yet done, **turn the Kill Switch OFF** (Kill wire disconnected from the ground) **for Running mode.**

Troubleshooting WiFi connection

- Check that the 12pins connector is FULLY inserted and there is nothing preventing the male connector from fully engaging.

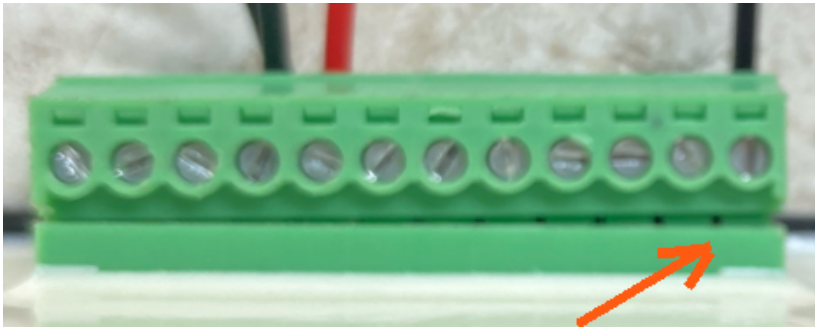

- Reboot the ignition box. (Power off/power up)

- Ignore any browser message saying it's not connected to internet. It's not an Error, it's a Warning:

ie: Firefox on W10:



Iphone11:



Indeed, **it's connected ONLY to the Ignition box, not to the web.**
(It's impossible to reach Google and the ignition box at the same time)

- You can see available SSID with a WiFi Monitor as [Wifi Analyzer for Android](#) or [Wifi-Analyzer for W10](#)
- You can test the network connection from your laptop to the ignition box:

Open a command Prompt:

Type "cmd" into the address bar of File Explorer and hit Enter or Press Windows+R to open "Run" box. Type "cmd" and then click "OK"

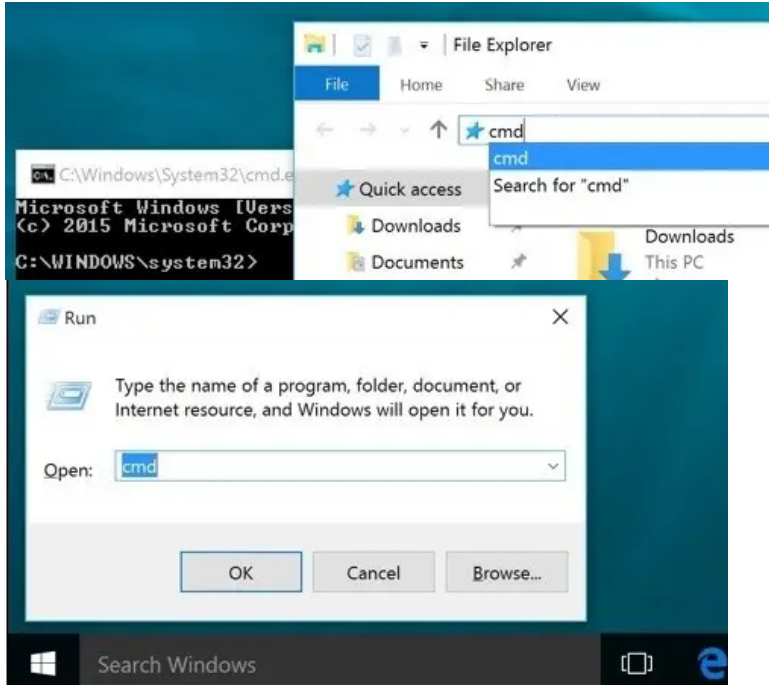

ping the ignition box, it should replies:

```
C:\>ping 192.168.4.1
```

```
Pinging 192.168.4.1 with 32 bytes of data :
```

```
Reply from 192.168.1.1 : bytes=32 time<1ms TTL=64
```

```
Reply from 192.168.1.1 : bytes=32 time<1ms TTL=64
```

```
Reply from 192.168.1.1 : bytes=32 time<1ms TTL=64
```

Clear DNS cache

Windows:	in MsDos console:	C:\> ipconfig /flushdns
MacOS:	in Terminal :	sudo dscacheutil -flushcache
Linux:	in Terminal:	sudo systemd-resolve --flush-caches

Troubleshooting display

Console URL is <http://> NOT [httpS://](https://) but some browsers like Chrome automatically switch to secure <https://>

- Use Firefox. Close all Firefox windows than relaunch it.

- or Use a lightweight, portable browser as [QtWeb](#)

- or [disable HSTS](#) In Chrome

iPhone won't connect to Wifi AP

Apple is full of features like probing the wifi connection by trying to connect to apple.com and rejecting the cnx if not possible, DNS probing, wifi switching, wifi assist, you name it

You may be not prompted for a password.

Apple devices try "weak" passwords in the background !

If it connected to SSID "Transmic_ign" (Check mark below) that means it guessed the right pwd.

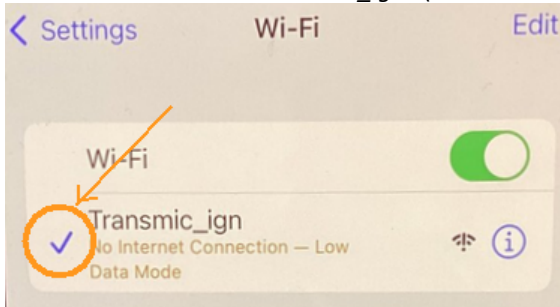

1) Disconnect Cellular data

2) Forget the "transmic_ign" SSID and connect to it again:

<https://youtu.be/yQKFOLIKlqo?si=A0CFfJYSo3uqEjml&t=18>

3) Remove interworking from the wifi configuration:

Settings > Cellular Data > Wi-Fi Calling: Off

4) Disable the automatic switch to mobile data when Wi-Fi connectivity is "poor"

Settings > Mobile Service > Wi-Fi Assist: off

<https://youtu.be/yQKFOLIKlqo?si=AaP1W3ZmdztTiKkh&t=162>

5) Disable WiFi Auto-join to your local network:

<https://youtu.be/9vM95hIBW-c?si=xnFNmgoxQUGXkSbj&t=18>

Check your WLAN settings under:

Settings > Maintenance > Support Info > System Config > Show System Config

Ignition Timing

Assuming you want this ignition curve:

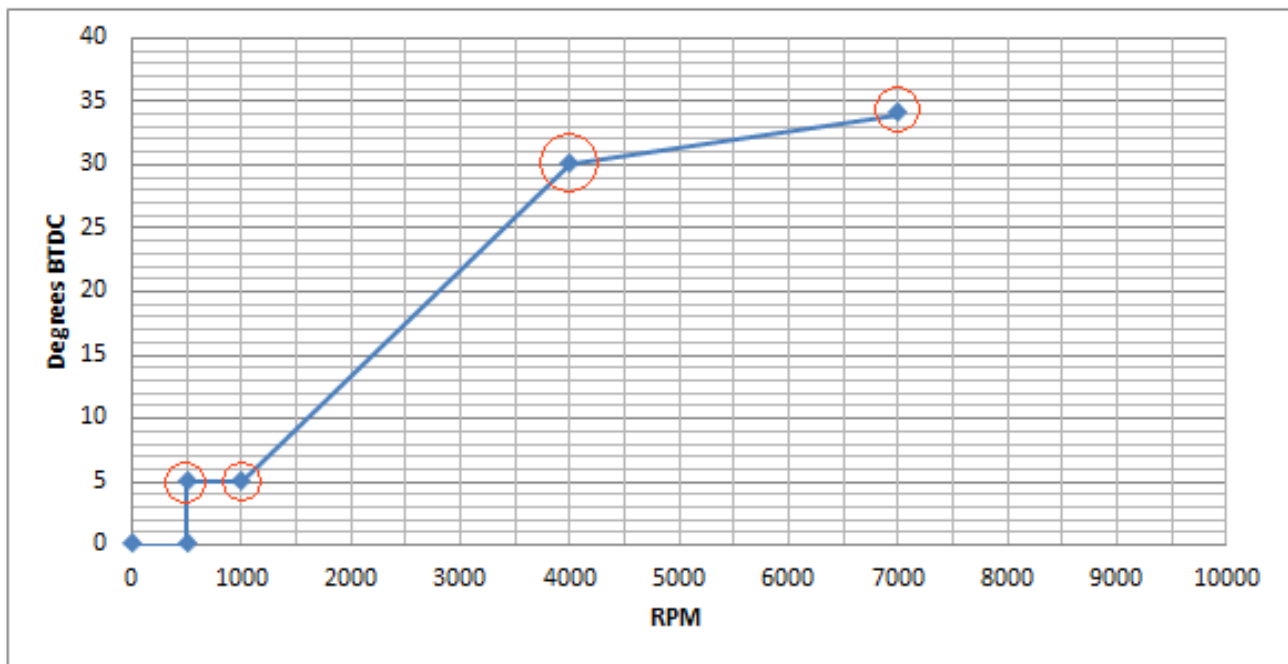

One can define this curve with 4 points but you can use up to 13 points.

0 to 500rpm is hard coded at 0° BTDC or ATDC for no kickback.

The curve above is defined by 4 pairs of values

500 rpm	=	5°	BTDC
1000 rpm	=	5°	BTDC
4000 rpm	=	30°	BTDC
7000 rpm	=	34°	BTDC

Those 4 couples of values MUST be filled out in the form consecutively and in ascending order of RPM along with the pickup position.

Use this Windows software to draw the curve: [Interactive_Graph.exe](#) with [Video](#)

Pickup Type

Default: 0

MENU	PICKUP TYPE	PICKUP POSITION
STROKES	SHAFT	CYLINDERS
ADVANCE TIMING	ADVANCE 0-500rpm	AUTO SPARK
DWELL	BYPASS	CONSOLE
MODIFY	UPDATE	

[0]

- 0: Analog Pickup Coil (VR-PN)
- 1: Analog Pickup Coil (VR-NP)
- 2: Digital Hall Effect Sensor *

Send

* option

Select the type of pickup attached to the Ignition box:

When the **LEADING** edge of the magnet passes in front of the pickup coil, a wave is produced and another wave of opposite voltage is generated when the **FALLING** edge of the magnet leaves the pickup coil.

Depending on the wiring, the first pulse at Leading Edge can be positive (then negative at Falling edge), or the exact opposite.

0 = VR stands for Variable Reluctor aka pickup coil/trigger coil (Analog signal) **Positive** first (PN)

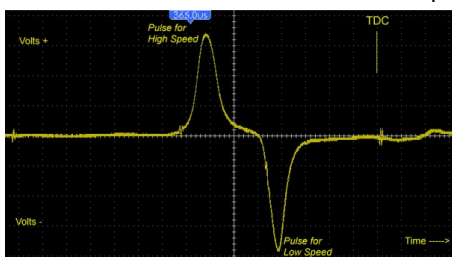

How to check the pickup polarity : <https://youtu.be/cLhaXoejBVQ>

1 = Variable Reluctor (Analog signal) **Negative** first (NP)

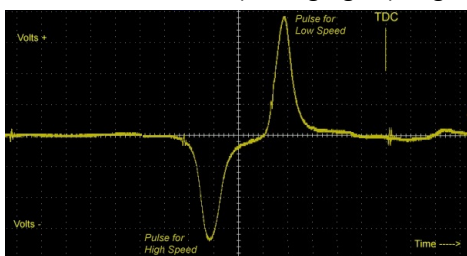

2 = Hall Effect Sensor (Digital signal)

This ignition box **works best with Positive first pickup (VR-PN)**

If the pickup is internally grounded into the stator there is no choice, the pickup output is either PN or NP

But if both pickup wires are available, then just [swap the wires](#) to change the polarity in order to get a **Positive first** signal (PN) on connector **pin7**.

Pickup voltage

In order to be detected by the ignition, the VR pickup MUST deliver sufficient voltage.
The higher the RPM, the more voltage it must produce.

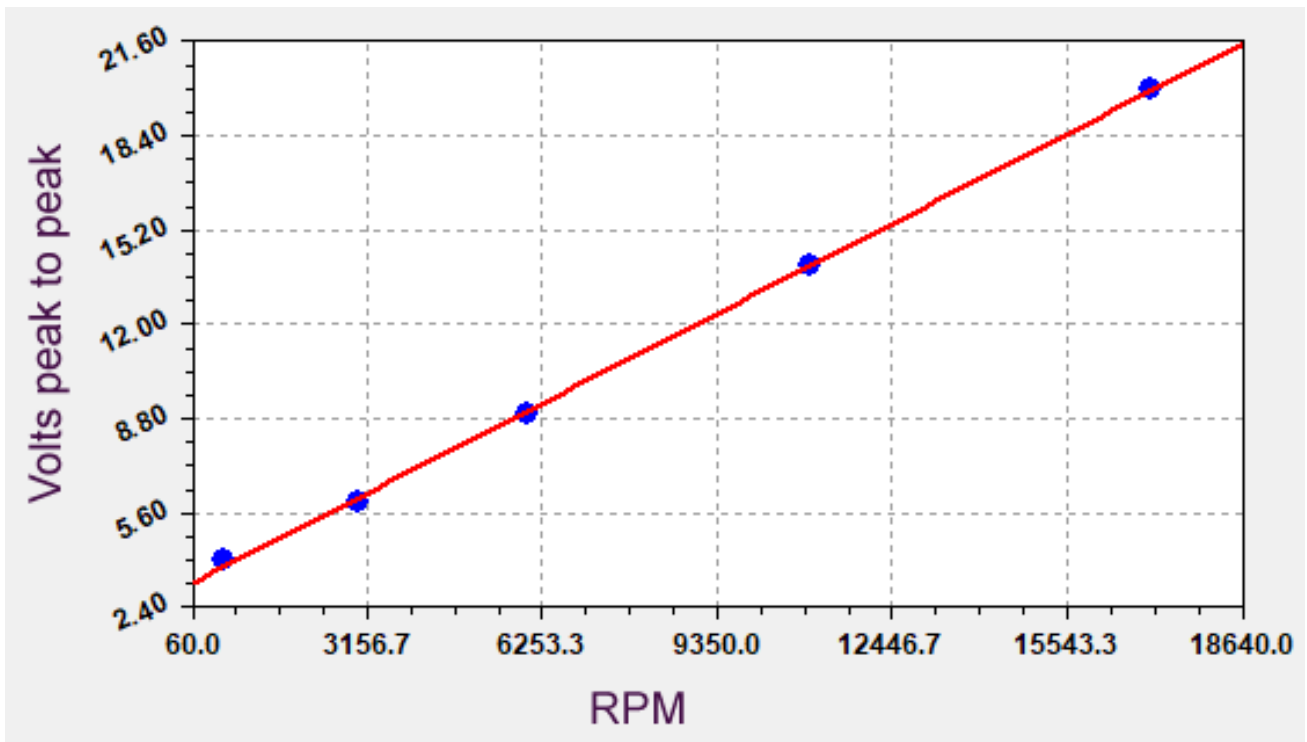

Formula :

$$\text{minimum Vpp voltage} = \text{RPM}/1000 + 3$$

Example :

At **6000rpm** the VR pickup must put out :

$$6000/1000 = 6$$

$$6 + 3 = \mathbf{9Vpp}$$

$$\mathbf{9Vpp = +4.5v \text{ to } -4.5v}$$

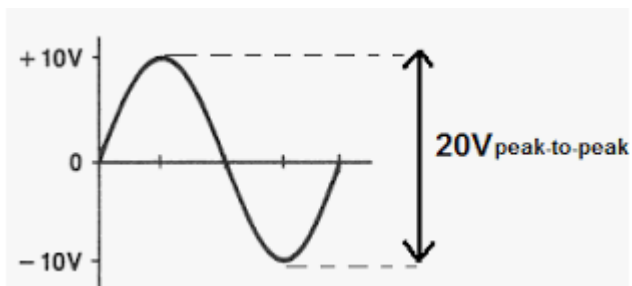

VR Pickup

Analog VR pickup is connected between pins 7 and 8(gnd)

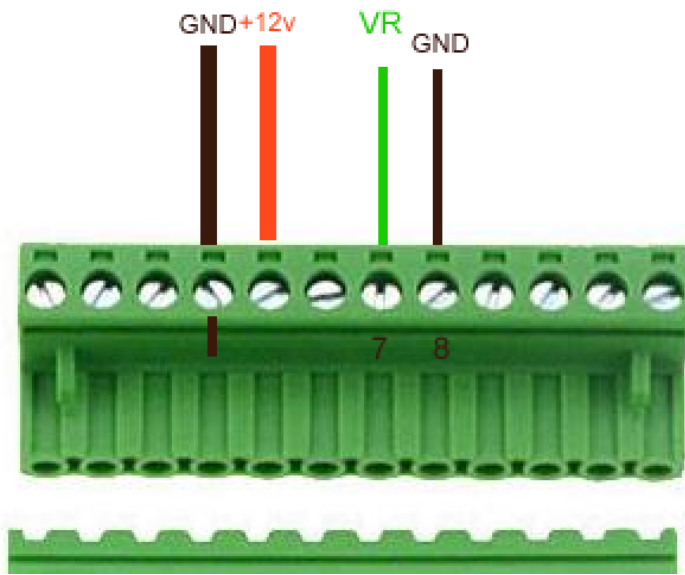

To avoid ElectroMagnetic Interference (EMI) it's safer to connect the pickup sensor through a shielded cable. Shield grounded on ignition box side only. Twisted pair is better.

Hall Sensor

A Hall Sensor can be connected between pins 9 and 8(gnd)

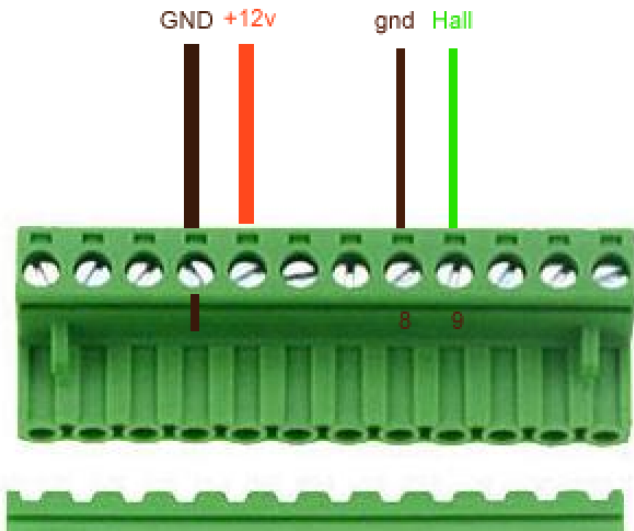

Pickup Type must be set to [2] for the use of a Hall sensor.

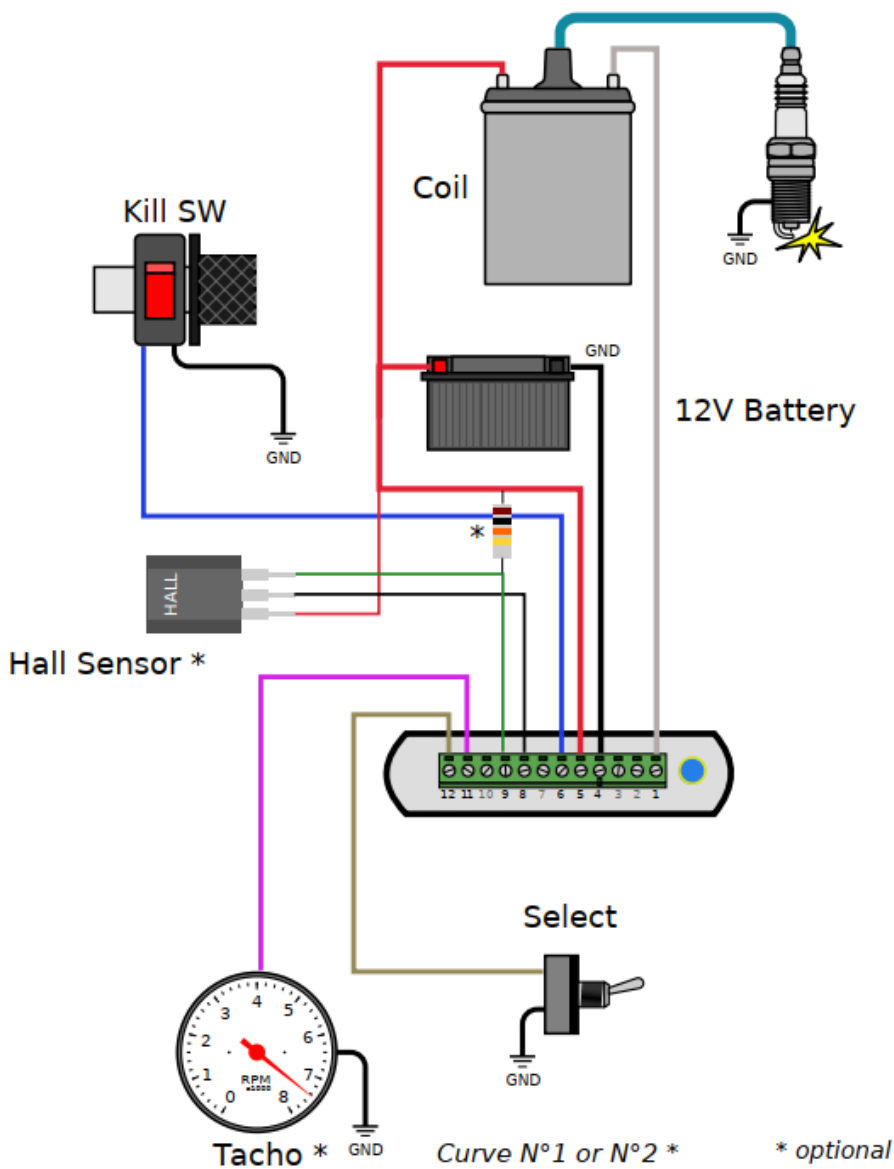

2 types of Sensors

- Hall sensors with **open-collector** output, give a floating voltage when no magnet. They need a pull-up resistor.

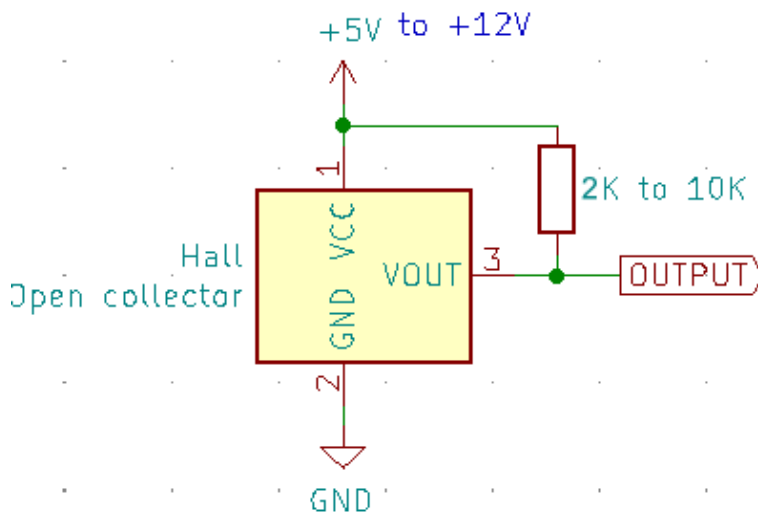

- Hall sensors with **built-in pull-up resistor** give positive voltage when no magnet.

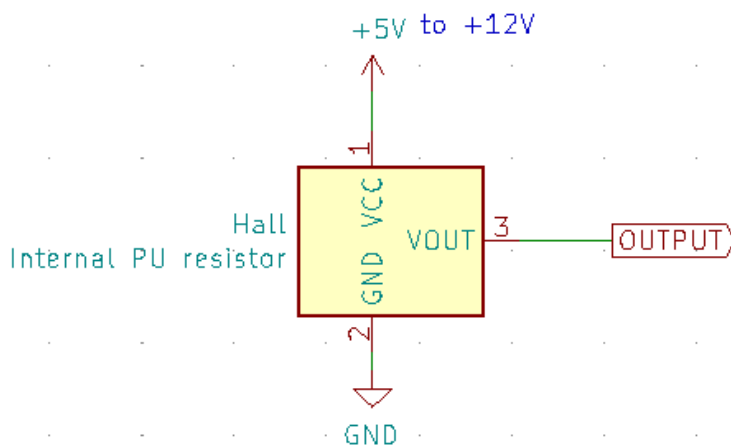

Hall sensors require a +5v to +12vdc supply voltage.

You can even connect an **Optical Sensor** as long as it puts out a **CLEAN square signal** similar to the one above.

See [Appendix 2](#) for Position

Output of a Hall sensor

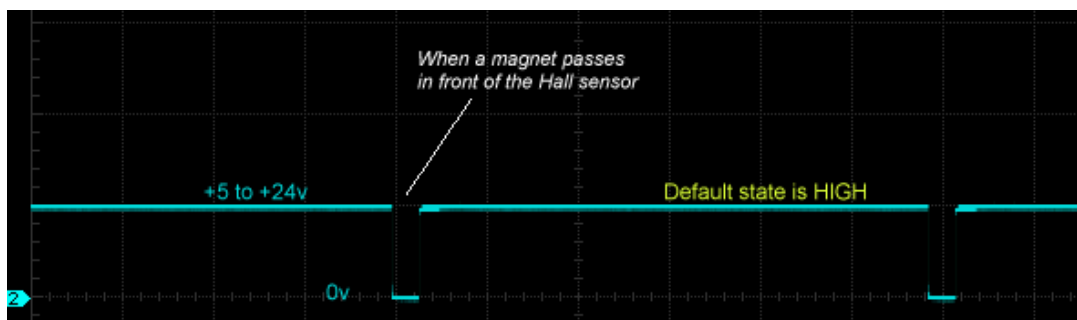

Timing

The ignition box uses the **rising edge** of the Hall sensor signal.



You can even connect an **Optical Sensor** as long as it puts out a **CLEAN** square signal similar to the one above.

Points

Points can be connected between pins 9 and 8(gnd)

First step:

Modify the wiring:

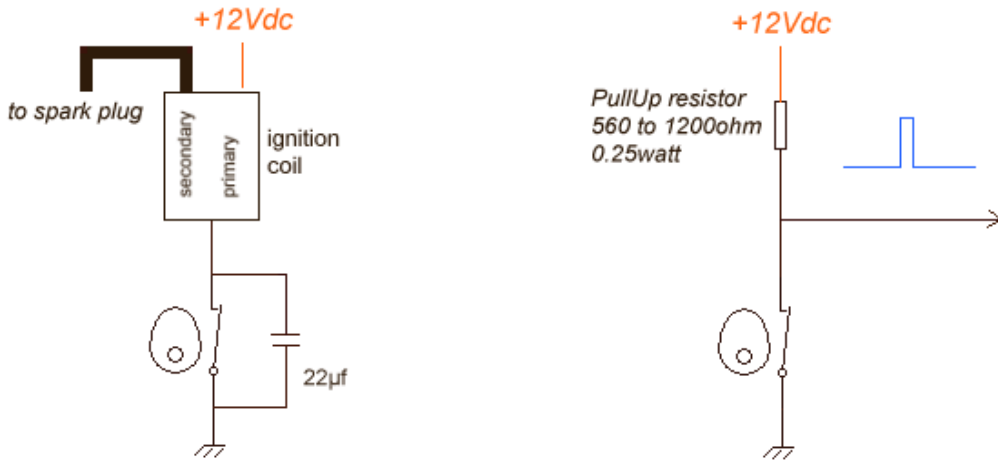

Second step:

Most conventional points have a mechanical advance with weights that change the timing depending on RPM. Now that TCI will be controlling the timing, you will need to lock out these mechanism.

2 possibilities:

A) You move the points or lock the mechanical timing to the **farthest advanced position**.

ie: If the mechanical system can shift the points until 30° BTDC. lock the points in this position and tell the TCI : "[Pickup Position is 30°](#)"

B) If Points don't have mechanical system or if you choose to lock the mechanical system for NO advance, then tell the TCI "[Pickup Position is at TDC](#)" by entering 360°

Pickup Position

Default: 50

Range of values: 1 to 360

MENU	PICKUP TYPE	PICKUP POSITION
STROKES	SHAFT	CYLINDERS
ADVANCE TIMING	ADVANCE 0-500rpm	AUTO SPARK
DWELL	BYPASS	CONSOLE
MODIFY		

[USERPOS]

BTDC

45

Send

- Go back to the browser and first thing first, enter the **Pickup Position** then click **Send**

Current value appears in blue on the form.

- **The Led flashes when value is processed.**

“Pickup Position” is the number of degrees between the very first pulse from the pickup and TDC

To be able to provide the largest advance timing (*Example 36° @ 4500rpm*) the pickup MUST send a trigger signal BEFORE the piston reaches 36° before top dead center (BTDC).

The “Pickup Position” on the Yam XT600 is 50°.

Many Yamaha have a “Pickup Position” of 72 degrees.

This “Pickup Position” depends on:

- Where the pickup is mechanically located with respect to TDC?
- Where is the flywheel’s bar located?
- How long is the flywheel’s bar?

“Pickup Position” is always greater or equal to “Max Advance”.

Formula is: **Pickup position = Base advance + Magnet Length**

Magnet Length:



Base advance is generally 5 to 15° BTDC. (*it sometime appears in the User Manuel.*)

See [Appendix 1,2,3 or 4](#) to find the physical position of the pickup relative to TDC.

Strokes

Default: 2

STROKES	SHAFT	CYLINDERS
ADVANCE TIMING	ADVANCE 0-500rpm	AUTO SPARK
DWELL	BYPASS	SECURITY
CONSOLE	MODIFY	UPDATE

[2]

- 2 strokes
- 4 strokes with Wasted Spark
- 4 strokes No Wasted Spark

Send

2 strokes : One pickup pulse every rotation

4 strokes with Wasted Spark : One pickup pulse every rotation = spark at TDC + wasted spark at BDC

4 strokes No Wasted Spark: One pickup pulse every 2 rotations = spark at TDC only

4 strokes with Wasted Spark is the most common case.

Shaft

Default: 0

MENU	PICKUP TYPE	PICKUP POSITION
STROKES	SHAFT	CYLINDERS
ADVANCE TIMING	ADVANCE 0-500rpm	AUTO SPARK
DWELL	BYPASS	CONSOLE
MODIFY		

[USERSFT]

- 0: CrankShaft
- 1: CamShaft
- 2: 2pulses/rev

Send

- Select if the pickup is placed :

- **0**: on the **crankshaft** via the flywheel (2stk) with 1 pulse per rotation
- **0**: on the **crankshaft** via the flywheel (4stk) with 1 pulse per rotation with wasted spark. *(one spark occurs during the compression stroke and another during the exhaust stroke.)*
- **1**: on the **camshaft** (4stk) with 1 pulse per 2 rotations.
- **2**: on the **crankshaft** with 2 pulses per rotation

Current value appears in blue on the form.

Advance Timing

Default: Empty

- Proceed now to enter the advance timing.

We want to setup:

500 rpm = 5° BTDC
 1000 rpm = 5° BTDC
 4000 rpm = 30° BTDC
 7000 rpm = 34° BTDC

Enter values consecutively in ascending order of RPM !

Pair 500:5 first etc etc...

7000 being the last value (as the firmware stops reading when it meets a null value),

7000 will act as the hard rev-limiter: No more sparks at 7001 RPM !

MENU	PICKUP TYPE	PICKUP POSITION
STROKES	SHAFT	CYLINDERS
ADVANCE TIMING	ADVANCE 0-500rpm	AUTO SPARK
DWELL	BYPASS	CONSOLE
MODIFY		

Curve N°1 or N°2*

USERTIM

RPM

ADV

 °

Curve

 (0=curve N°1)

Send

* Option

Stored Values:

Timing Curve 1:

0	500
4	5
8	1000
12	5
16	3000
20	40
24	8000
28	30
32	0
36	0
40	0
44	0

RPM can be entered with a 100rpm step but RPM will be measured with **1rpm** precision.

Timing can be entered with a precision of 1° but the processor calculate all timing values between the points you entered using linear interpolation so an **accuracy of 0.1°** is done at this step.

Any timing values will be **COMPLETELY OFF IF PICKUP POSITION IS FALSE: PICKUP POSITION IS KEY**

See [Appendix 1,2,4](#) for Position

Curve N°1 is stored from addresses 0 to 100

Dwell

Default: 3

Range of values: 1 to 6

Dwell time is the charge time for the ignition coil.

It vary with different types of ignition coil and is typically 2 milliseconds for many modern coils to 4 or 5 milliseconds for older ignition coils.

Spark appends when the current flow is stopped **after** Dwell time.

MENU	PICKUP TYPE	PICKUP POSITION
STROKES	SHAFT	CYLINDERS
ADVANCE TIMING	ADVANCE 0-500rpm	AUTO SPARK
DWELL	BYPASS	CONSOLE
MODIFY		

[3]



Send

Current value appears in blue on the form.

Keep in mind that the longer the Dwell time, the lower the max RPMs

Select curve

Default: curve N°1

If you bought the 2 curves option, then connect a switch between connector **pin 12 and ground**.

When the switch is **open** (or no switch connected), **curve N°1** will be used.

If switch is **on** (*pin 12 connected to ground*) BEFORE turning on the ignition box, then **curve N°2** will be used.

You cannot change the curve while running.

MENU	PICKUP TYPE	PICKUP POSITION
STROKES	SHAFT	CYLINDERS
ADVANCE TIMING	ADVANCE 0-500rpm	AUTO SPARK
DWELL	BYPASS	CONSOLE
MODIFY		

Curve N°1 or N°2*

500 => 14

RPM

3000

ADV

14

Curve

1 (0=curve N°1)

Send

* Option

96	0
100	0

Timing Curve 2:

104	501
108	5
112	1001
116	8
120	3001
124	30
128	10001
132	40
136	0
140	0
144	0
148	0
152	0
156	0
160	0
164	0
168	0
172	0
176	0
180	0
184	0
188	0
192	0
196	0
200	0
204	0

Settings:

Curve N°2 is stored at addresses 104 to 204

Security

Default: 0

Range of values: 0 to 2

Pin 10 is a security input for Neutral, clutch or sidestand switches.

It can be configured in 3 ways:

- 0 = unused No security. *Pin10 is not connected*
- 1 = gnd2run pin10 MUST be grounded in order to run the ignition.
- 2 = gnd2kill pin10 kill the ignition when grounded.

MENU	PICKUP TYPE	PICKUP POSITION
STROKES	SHAFT	CYLINDERS
ADVANCE TIMING	ADVANCE 0-500rpm	AUTO SPARK
DWELL	BYPASS	SECURITY
CONSOLE	MODIFY	UPDATE

[0]

- 0: Unused
- 1: gnd2run
- 2: gnd2kill

Send

To use more than one security, use diodes to make a "OR" gate:

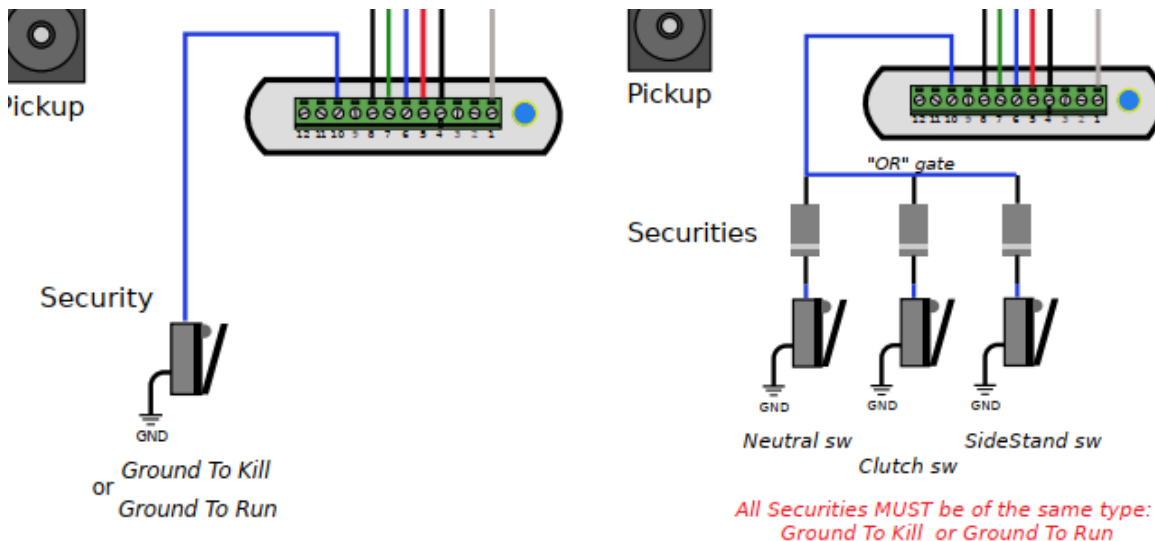

Shifter

Default: 70

Range of values: 0 to 200

Pin 10 is an optional input for a [Shifter sensor](#).

It can be configured in 2 ways:

0 = unused

No Shifter. Pin 10 is used for [Security](#)

10 to 200

Pin 10 is used for Shifter input.

When pin10 is grounded by the quick-shifter sensor, there is no sparks during 10 to

200ms

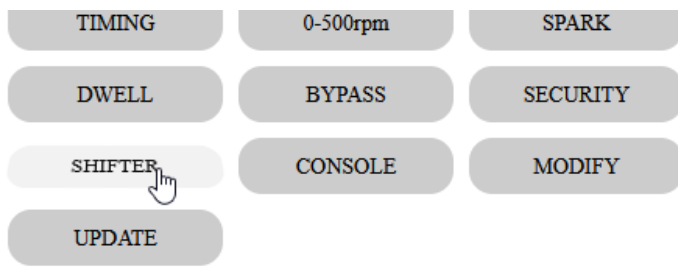

[0]

Cut duration

70 ms

Send

** Shifter is a paid option*

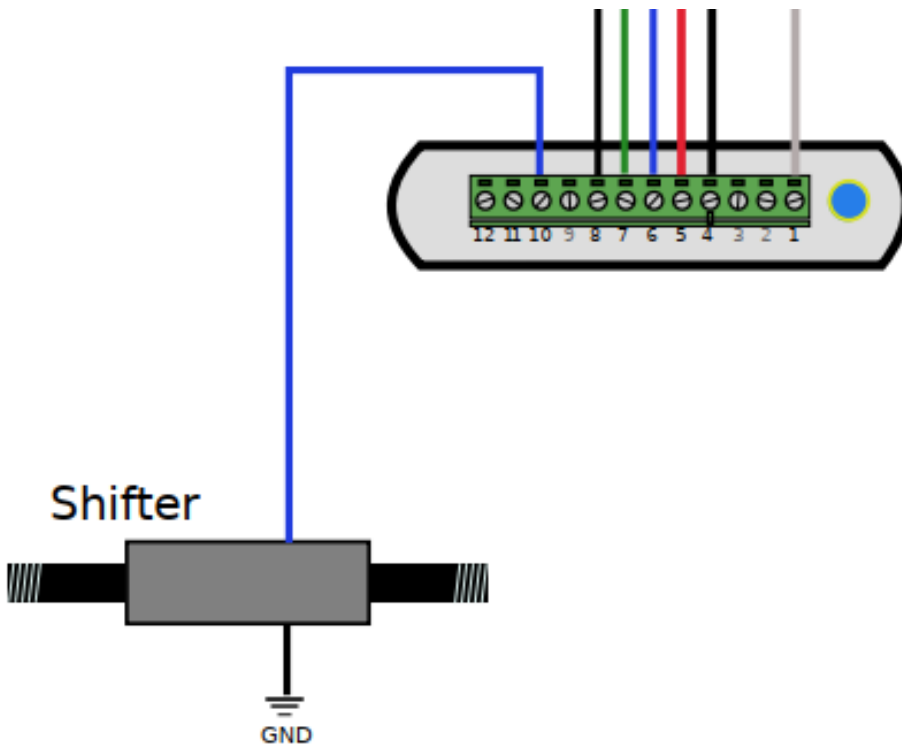
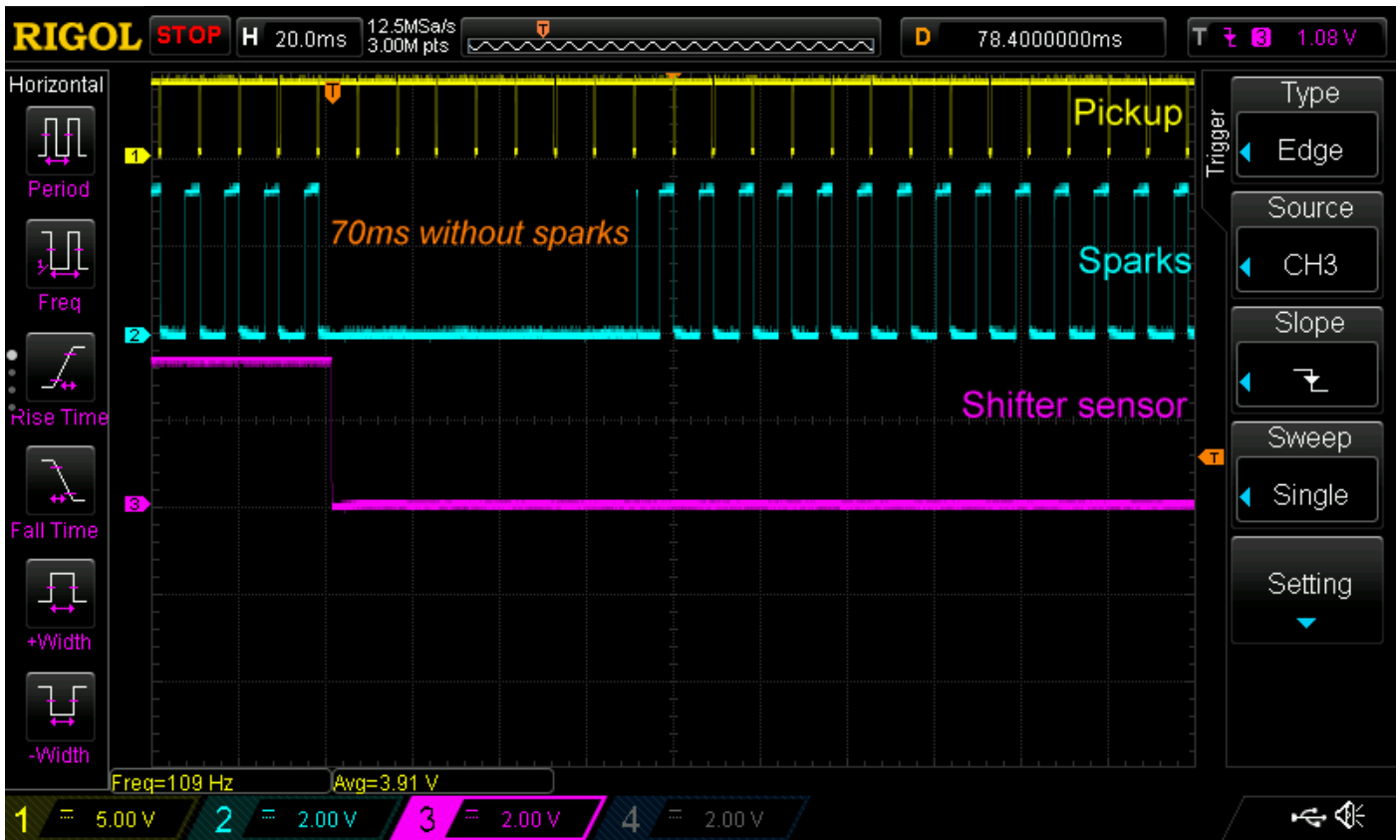

Read

- To display the values that have been set, click on the **Read** button on the **Menu** page :

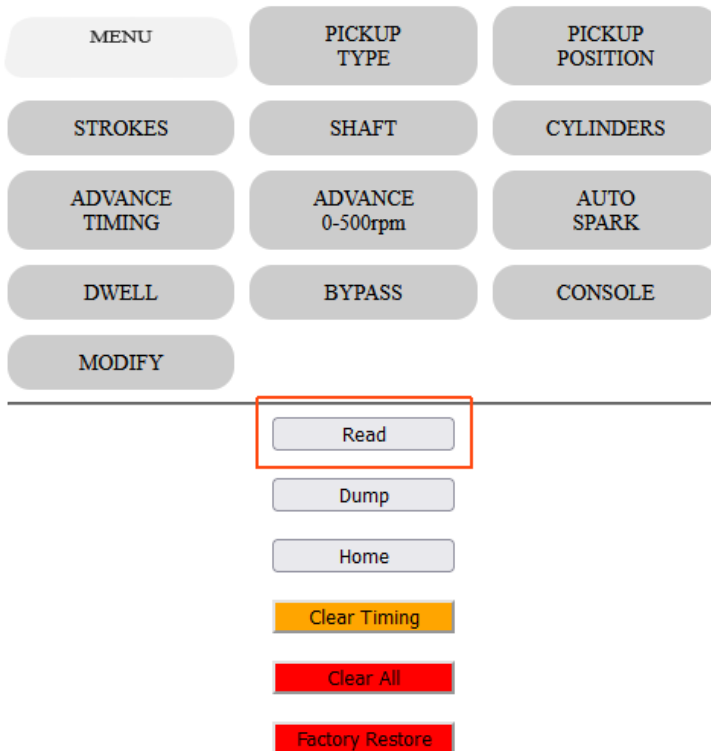

Stored Values:

Timing Curve:

0	500
4	5
8	1000
12	5
16	4000
20	30
24	7000
28	34
32	0
36	0
40	0
44	0
48	0
52	0
56	0
60	0
64	0
68	0
72	0
76	0
80	0
84	0
88	0
92	0
96	0
100	0



exit

Stored Values:

Timing Curve:

0	500
4	5
8	1000
12	5
16	4000
20	30
24	0
28	0
32	0
36	0
40	7000
44	34
48	0
52	0
56	0
60	0
64	0
68	0
72	0
76	0
80	0
84	0
88	0
92	0
96	0
100	0



exit

204 0

Settings:

208	0	Autospark (TCI)
212	0	Pickup Type
216	50	Pickup Position
220	0	DwellType (TCI)
224	3	Dwell (TCI)
228	0	Console output
232	0	Bypass (TCI)
236	0	Adv 0-500rpm
240	0	
247	0	Shaft
248	5	Starts

Home

Dump

Read EEPROM addresses and display them in HEX values for debug purpose.

Click on the **Dump** button on the **Menu** page :

The menu page contains several buttons for navigation and settings:

- MENU
- PICKUP TYPE
- PICKUP POSITION
- STROKES
- SHAFT
- CYLINDERS
- ADVANCE TIMING
- ADVANCE 0-500rpm
- AUTO SPARK
- DWELL
- BYPASS
- CONSOLE
- MODIFY

Below the menu is a control panel with the following buttons:

- Read
- Dump** (highlighted with a red box)
- Home
- Clear Timing
- Clear All
- Factory Restore

Dump EEPROM Hex Values:

0	F4	01	00	00	05	00	00	00
8	40	1F	00	00	28	00	00	00
16	34	21	00	00	28	00	00	00
24	00	00	00	00	00	00	00	00
32	00	00	00	00	00	00	00	00
40	00	00	00	00	00	00	00	00
48	00	00	00	00	00	00	00	00
56	00	00	00	00	00	00	00	00
64	00	00	00	00	00	00	00	00
72	00	00	00	00	00	00	00	00
80	00	00	00	00	00	00	00	00
88	00	00	00	00	00	00	00	00
96	00	00	00	00	00	00	00	00
104	00	00	00	00	00	00	00	00
112	00	00	00	00	00	00	00	00
120	00	00	00	00	00	00	00	00
128	00	00	00	00	00	00	00	00
136	FE	00	00	00	00	00	00	00
144	00	00	00	00	00	00	00	00
152	00	00	00	00	00	00	00	00
160	00	00	00	00	00	00	00	00
168	00	00	00	00	00	00	00	00
176	00	00	00	00	00	00	00	00
184	00	00	00	00	00	00	00	00
192	00	00	00	00	00	00	00	00
200	00	00	00	00	00	00	00	00
208	00	00	00	00	00	00	00	00
216	32	00	00	00	00	00	00	00
224	02	00	00	00	00	00	00	00
232	00	00	00	00	00	00	00	00
240	00	00	00	00	01	00	00	00

Home

Modification

Say you want to modify the advance timing for 7000rpm and set 35° instead of 34°

In *Read* mode above, we saw that RPM 7000 is stored at address 24 and timing for 7000rpm is at address 28.

24	7000
28	34
32	0

Since we want to modify the advance timing at line 28, we now have to enter :

Line **28**
New value **35**
then **Send**

DWELL BYPASS CONSOLE

MODIFY

LINE
28

NEW VALUE
35

Send

Same thing to change any other values.

Remember: **All timing values must be in ascending order of RPM !**

Use Read button to check that.

Add points

Say you want **to add** one advance timing of 34° @ 8000rpm

In *Read* mode above, we saw that last RPM 7000 is stored at address 24 and timing for 7000rpm is at address 28.

The next 2 **empty** slots available are:

24	7000
28	34
32	0
36	0
40	0

Address **32** for RPM and Address **36** for timing

We now have to enter :

Line **32**
New value **8000**
then **Send**

Line **36**
New value **34**
then **Send**

Remember: **All timing values must be in ascending order of RPM !**

Use Read button to check that!

Clear points

Say you want to remove the last advance timing of 34° @ 7000rpm

In *Read* mode above, we saw that last RPM 7000 is stored at address 24 and timing for 7000rpm is at address 28.

24	7000
28	34
32	0
36	0
40	0

To zero out those values we now have to enter :

Line **24**
New value **0**
then **Send**

Line **28**
New value **0**
then **Send**

Remember: All timing values must be **consecutive** and in **ascending** order of RPM !
Use *Read* button to check that.

Stored Values:

Timing Curve:

0	500
4	5
8	1000
12	5
16	4000
20	30
24	0
28	0
32	0
36	0
40	7000
44	34
48	0
52	0
56	0
60	0
64	0
68	0
72	0
76	0
80	0
84	0
88	0
92	0
96	0
100	0



exit

Clear Timing

This button will **clear TIMING values** WITHOUT confirmation.

Pickup position, polarity, shaft, dwell etc are kept.

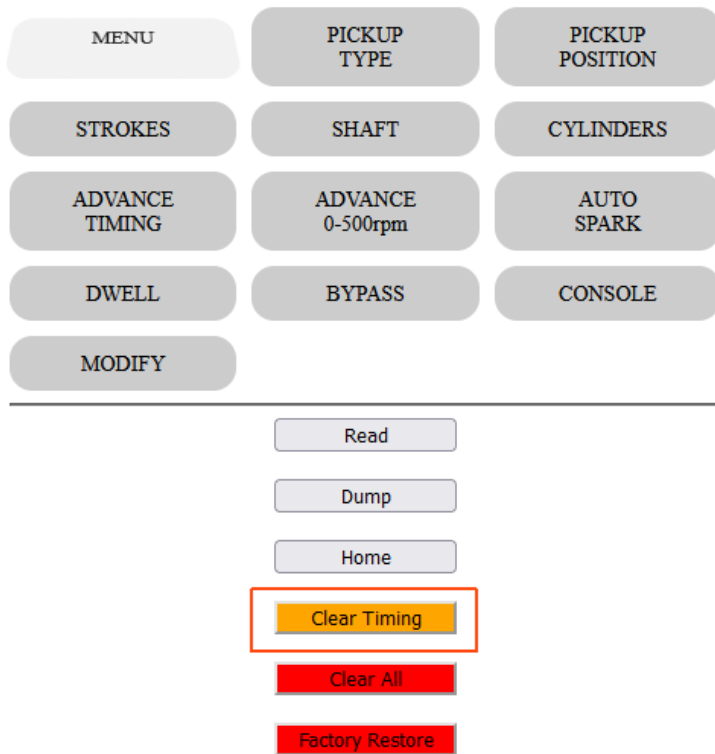

Browser shows :

Timing values cleared!

Please restart the ignition box.

This box now has no Advance Curve and cannot operate until you set timing values.

Restart the ignition box. (power off/power on)

Don't forget the Kill switch position if you want to return in Setup mode....

Clear All

This button will **clear ALL values** WITHOUT confirmation. (Paid options are kept)
Timing, Pickup position, polarity, shaft, dwell etc are zeroed.

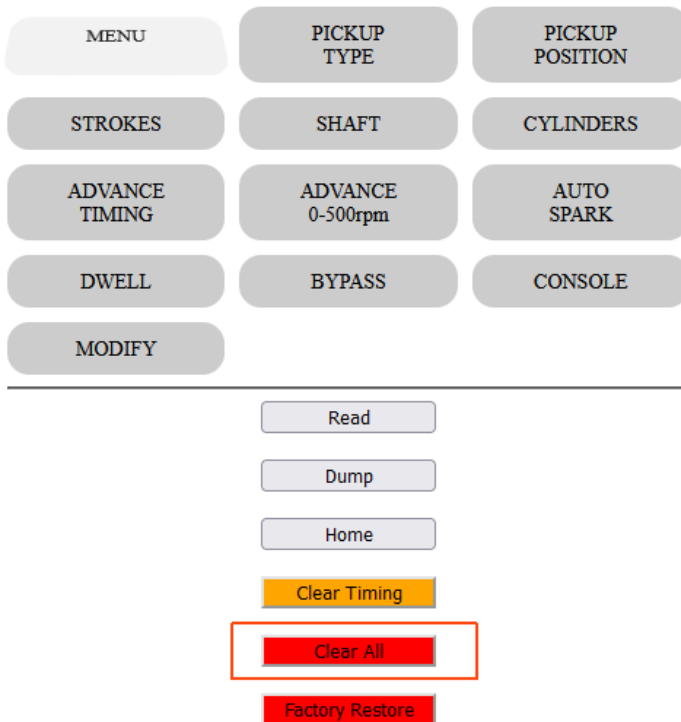

Browser shows :

EEPROM values cleared!

Please restart the ignition box.

This box is now empty and cannot operate until you set values. '

Restart the ignition box. (power off/power on)

Don't forget the Kill switch position if you want to return in Setup mode....

Factory Restore

This button will **Restore Factory Default** WITHOUT confirmation. (Paid options are kept)

Timing, Pickup position, polarity, shaft, dwell etc are set to default values.

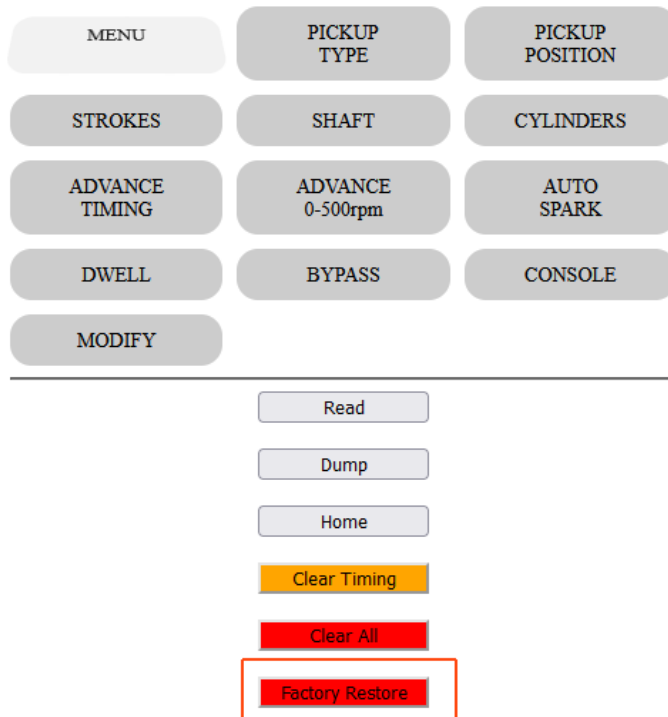

Browser shows :

Init All done!

This box now have a default Advance Curve which is not the one you need...
Tune the values before to start the engine!

Restart the ignition box. (power off/power on)

Don't forget the Kill switch position if you want to return in Setup mode....

Advanced settings

If you don't need those Extra settings, just let them to their default value.

Advance at kick start

Default: 0

Range of values: 0 to 10

For an easier Manual Kick start and to avoid kick backs, you can delay the advance between 0 to 500rpm to send the spark a few degrees **After** Top Dead Center (ATDC)

MENU	PICKUP TYPE	PICKUP POSITION
STROKES	SHAFT	CYLINDERS
ADVANCE TIMING	ADVANCE 0-500rpm	AUTO SPARK
DWELL	BYPASS	CONSOLE
MODIFY		

[0]

ATDC

5 °

Send

Current value appears in blue on the form.

Tech info:

If the measured period/rpm is less than 500rpm, the CPU uses the measured rpm (ie 320rpm) to determine when the next TDC will append during the next revolution, assuming the rpm remains constant.

If the engine speed decrease due to low inertia, the TDC calculation will be incorrect, resulting in an early spark.

To address this issue, the CPU adds an offset to the calculation, which equals the value of the "Advance 0-500" tab that the user may have set.

i.e., if the user specifies 20° ATDC, the CPU will calculate the theoretical next TDC and add 20° to the result.

If the measured rpm is over 500rpm, the CPU read the advance timing map the user has set to find which advance must be applied for this specific RPM (ie520rpm). No user offset will be used.

AutoSpark

Default: Off

Range of values: Off, 300 1000, 3000, 10000rpm

This **autotest function** is usable on TCI and DCCDI only.

On **Running mode**, the box fires the ignition coil by itself at 300/1000/3000/10000rpm WITHOUT any pickup connected.

This way you can test the ignition box, wiring, ignition coil, sparkplug wire and sparkplug.

Of course, remove the sparkplug from the cylinder head and connect the metal part to the frame.

MENU	PICKUP TYPE	PICKUP POSITION
STROKES	SHAFT	CYLINDERS
ADVANCE TIMING	ADVANCE 0-500rpm	AUTO SPARK
DWELL	BYPASS	CONSOLE
MODIFY		

[0]

- 0: Off
- 1: 300rpm
- 2: 1000rpm
- 3: 3000rpm
- 4: 10000rpm

Send

Current value appears in blue on the form.

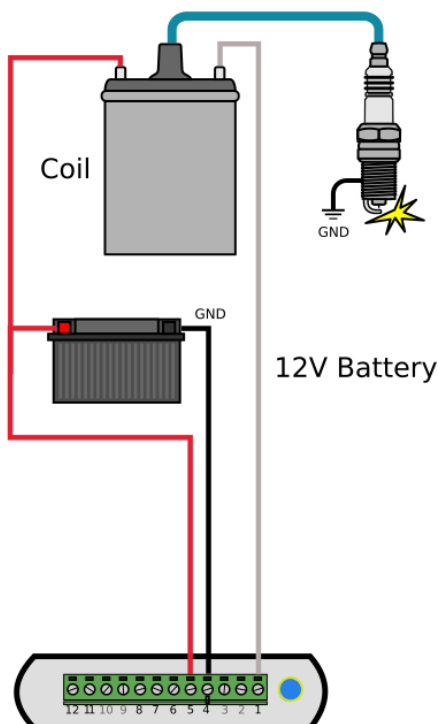

Bypass

Default: Off

This function bypass the advance timing and trigger a spark AS SOON AS a pickup pulse has been detected.

This function comes handy when you want to know the pickup position with a Timing Lamp :

Remove the sparkplug out of the engine and connect it to the metal frame, then rotate the engine with a drill machine.

With points and mechanical advance system, TCI in Bypass mode is acting as a simple Transistorized Ignition.

/!\ Don't use the function on a running engine fitted with pickup or hall sensor otherwise the spark will append way too soon and can harm the piston !!

MENU	PICKUP TYPE	PICKUP POSITION
STROKES	SHAFT	CYLINDERS
ADVANCE TIMING	ADVANCE 0-500rpm	AUTO SPARK
DWELL	BYPASS	CONSOLE
MODIFY		

[0]

- 0: Off
- 1: On

Send

Current value appears in blue on the form.

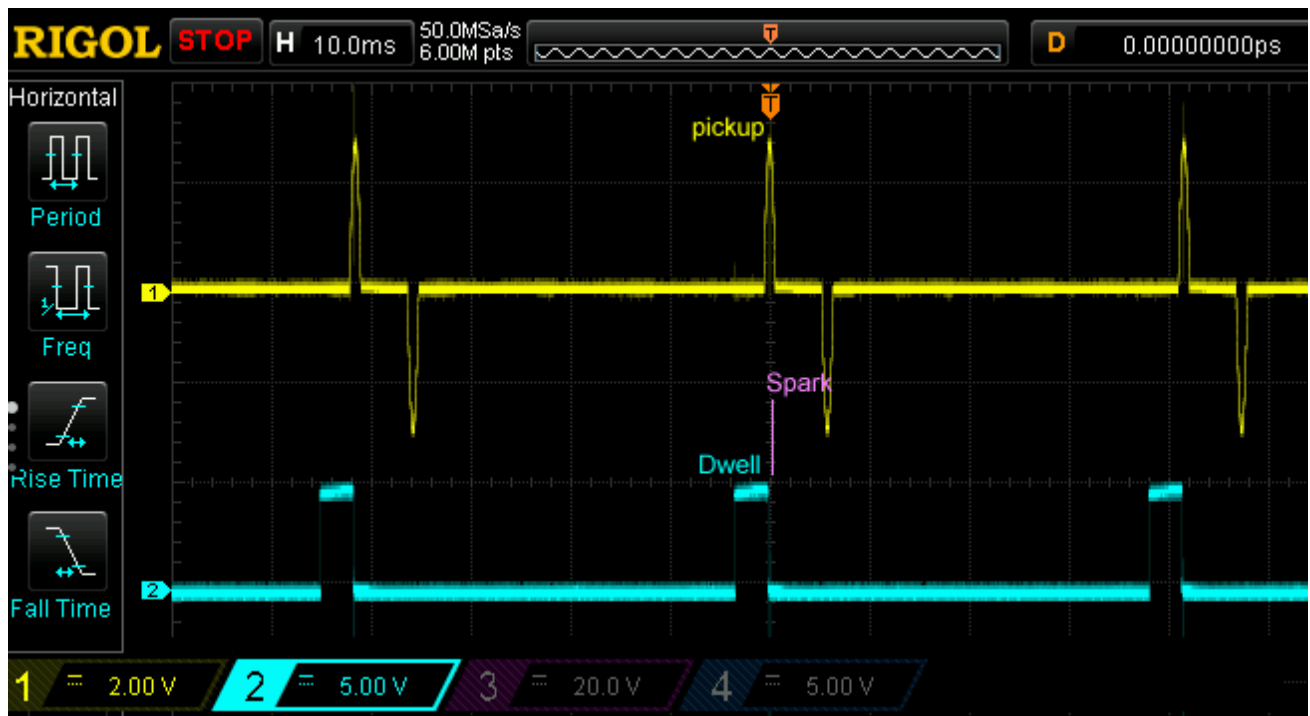

Console

Default: Off

Enable the Console output:

- Turn the ignition box in [Setup Mode](#)
- Go to "**CONSOLE**", check "1" to enable the console output, press Send

DWELL BYPASS CONSOLE

MODIFY

[0]

0: Off
 1: On

Send

Current value appears in blue on the form.

- Power **off** the ignition box
- **Disconnect** the **Kill** wire from ground
- 1) **Power on** the ignition box, it goes in "**Run Mode**"
- 2) The **LED** flashes once if curve N°1 is selected or flashes twice for curve N°2
- 4) The ignition box also creates a **WiFi AP** (*Access Point*)
- 5) On your phone, laptop, PC, whatever, go to the **Wifi setting** and search for a new SSID called **Transmic_ign**
You can see available SSID with a Wifi Analyzer as [NetSpot for Android](#) or [Wifi-Analyzer for W10](#)

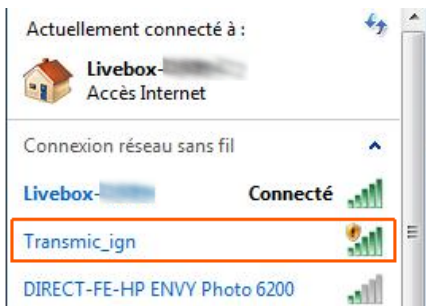

6) **Connect** to it. Password is required: it's "*password*"

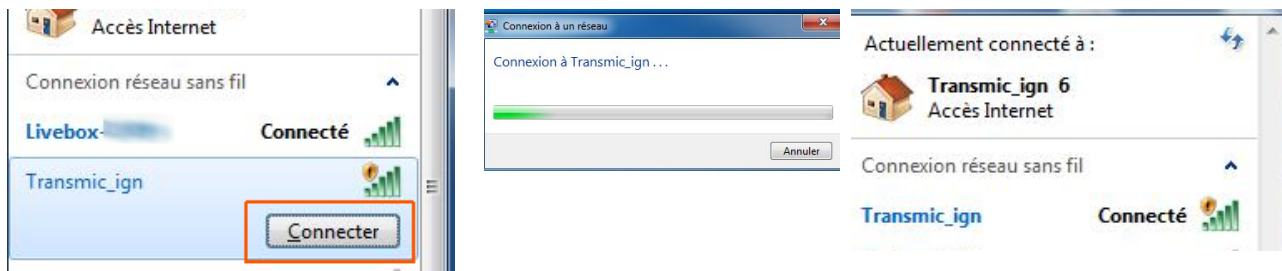

7) **Start** the engine

8) Once your device is connected to the AP, open up a **browser** and head over to

- Up to TClv12r7c0

<http://192.168.4.1>

- From TClv12r7c1

<http://192.168.4.1/console>

9) After a few seconds, the browser should display both the **RPM and the advance timing** in degrees BTDC followed by 2 bargraphs

RPM vs ADV

3360

39.29

rpm: 
adv: 

Display appears ONLY when the engine is running.

Because of the impact on Ignition box performance, please use it for debug only and disable this function when you are done with it!

Troubleshooting

Console URL is **http://** NOT **https://** but some browsers as Chrome automatically switch to **https://**

Workarounds

- Use Firefox. Close all Firefox windows than relaunch it.
- Use a lightweight, portable browser as [QtWeb](#)
- In Chrome, disable **HSTS** (*HTTP Strict Transport Security*) that forces to open websites in HTTPS:
 - Write **chrome://net-internals/#hsts** in the address bar.
 - Scroll down the page to :

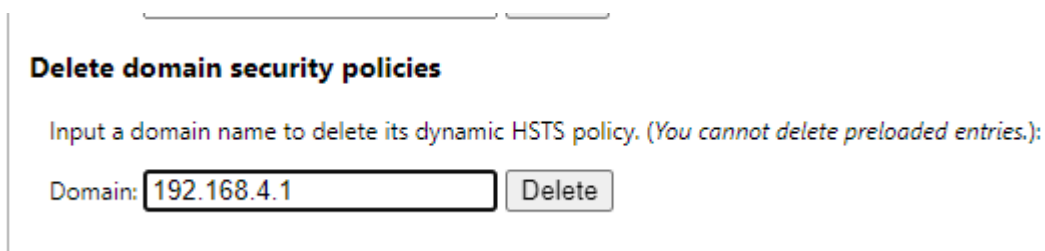

- add **192.168.4.1** and hit **Delete** to disable Force https for this particular website.

Running Mode

- 1) **Disconnect** the **Kill** wire from ground if you previously went into [Setup Mode](#)
- 2) **Power on** the ignition box, it goes in normal "**Run Mode**"
- 3) The **LED** stays On waiting for pickup signal.
- 4) Start the engine. The LED **blinks** in time **with RPM**.
- 5) When the engine runs, if **Kill** wire is connected **to ground** then it **stops** the engine.

Update firmware

- 1) Turn the ignition box in "Setup" mode
- 2) Under "UPDATE" tab, check "Enabled" > Send

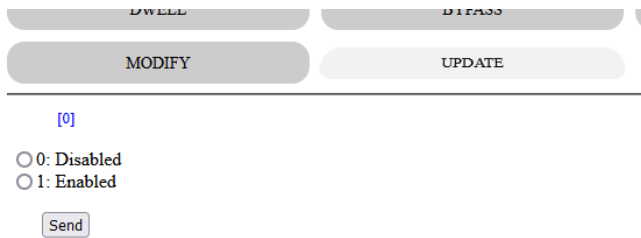

Android

- 3) On your SmartPhone pull down from the top of the screen and navigate to Settings > Tap Network & Internet > Go to Hotspot & tethering

Tap WiFi hotspot and set Hotspot name = **transmic**

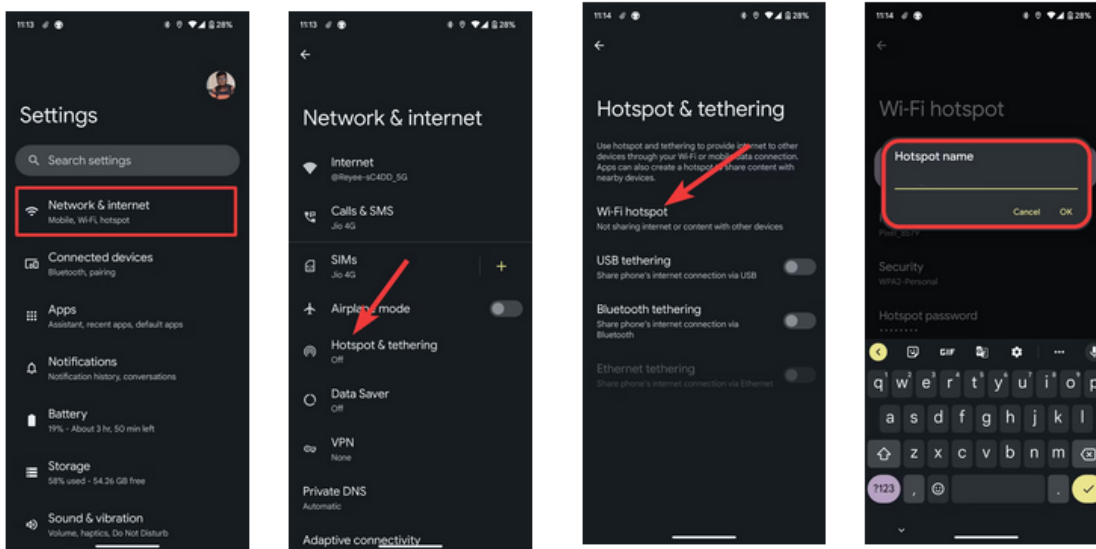

Set the "Hotspot password" to **update4ignition** > Turn on the Wifi hotspot

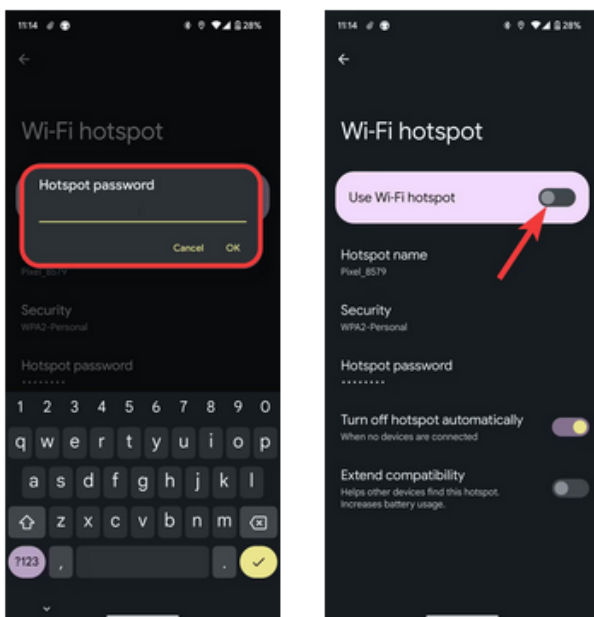

Security should be WPA2

Band should be 2.4GHz

Video : <https://youtu.be/mYplGVcX2sQ?t=74>

4) Check that your smartphone can reach the internet server :

Open a browser > go to <http://update.transmic.fr:84/>

You should read smth like :

Last Firmwares Versions

Type	CDI	TCI
V14		v14r0c0

5) Connect **KILL** wire to ground on the ignition box

6) **Restart** the ignition box

The **Led** blinks 5 times meaning grounded Kill switch has been detected.

7) Led flashes every second while searching for the wifi hotspot.

Led goes off when connected to hotspot and while trying to reach the update server.

[Understanding update status with led \(video\)](#)

A new firmware is available :

LED is on while downloading data from the network. Off while writing data to the box.

After 30-45 seconds, the led turns off and the ignition box restart.

Because the kill wire is still connected to ground, the box will restart in Setup mode, open a wifi AP and display the updated version on the home page.

Remove the kill wire from the ground.

Power off the ignition box.

There is no firmware available :

The Led blinks continuously 3 times per second indicating the update control has been completed.

Remove the kill wire from the ground.

Power off the ignition box.

IPhone

To change the Hotspot name you have to change your iPhone's name (!!!)

Settings > general > About > Name

Enable your hotspot:

Settings > Cellular > Personal Hotspot > wifi Password > done > Allow others to join

Appendix 1

Find the physical position of the analog **pickup** relative to Top Dead Center.

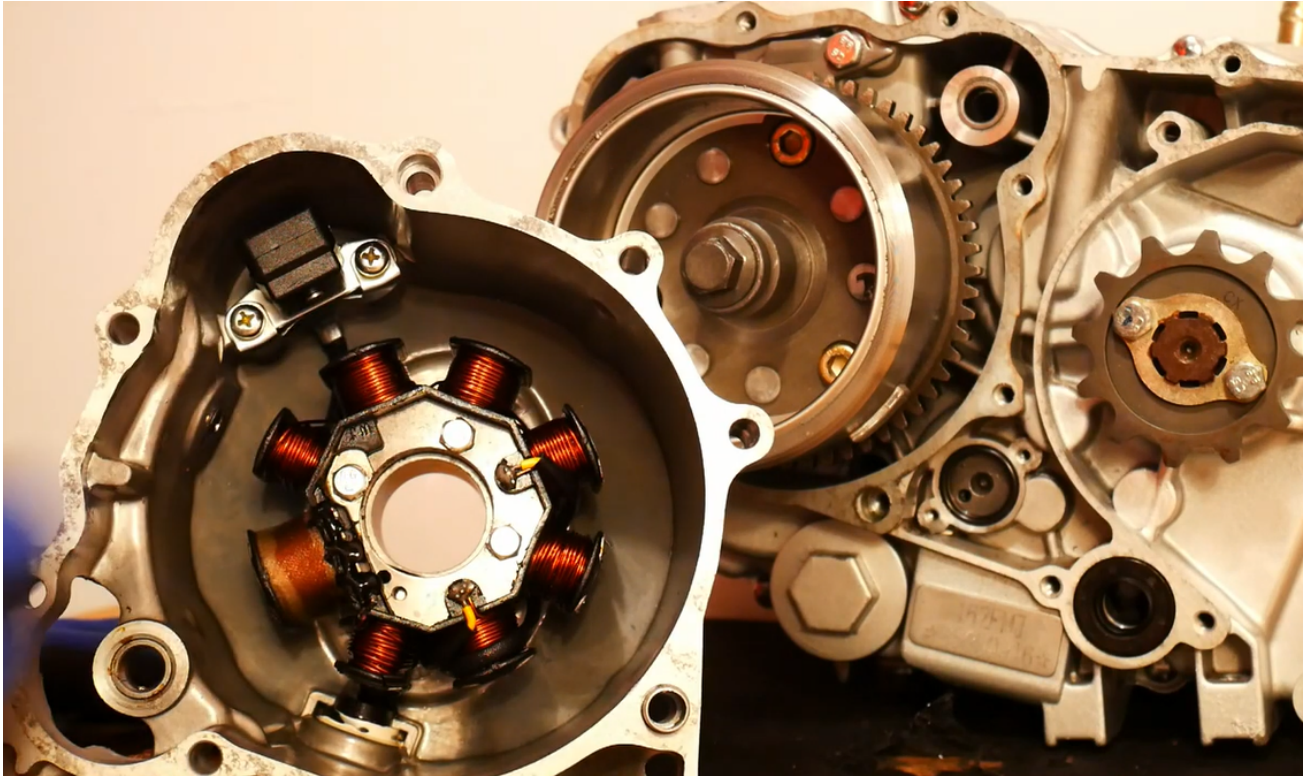

In this example below the pickup/sensor is set at 39° BTDC

Method 1:

- *First align the pickup with the rising edge of the bar.*
(Pay attention to direction of rotation of the crankshaft: CW or CCW)
- *Measure the angle between the TDC mark on the casing and the TDC mark on the rotor*

Method 2:

- *Remove the sparkplug, rotate the engine to put the piston at TDC*
(If TDC marks on casing and rotor exist, then they should be aligned.)
- *Measure the angle between the pickup and the rising edge of the bar.*
(Pay attention to direction of rotation of the crankshaft: CW or CCW)

Method N°1

Pickup aligned with rising edge

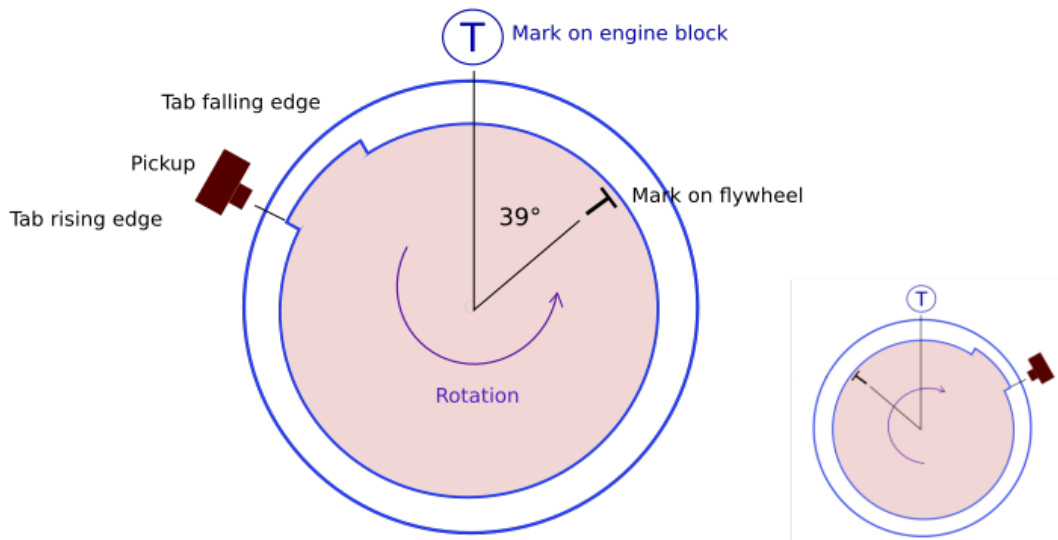

Method N°2

Engine at TDC

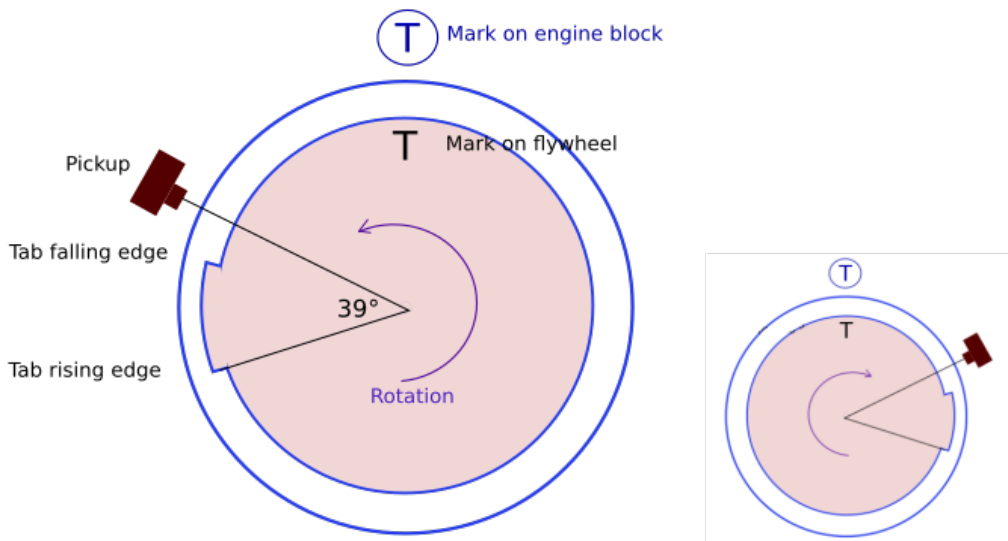

Leading|Rising edge generate pulse for high revs
Trailing|Falling edge generate pulse for idle.

calageTDC_pickup_2methods.svg

This view above represents the respective positions of the rotor and the pickup as we would see them if the engine cover were transparent.

Read timing from flywheel: <https://transmic.fr/2021/09/23/read-timing-from-flywheel/>

Appendix 2

Find the physical position of the digital **Hall Sensor** relative to Top Dead Center.

In the example below the sensor is set at 39° BTDC

Method N°1 Hall sensor aligned with falling edge

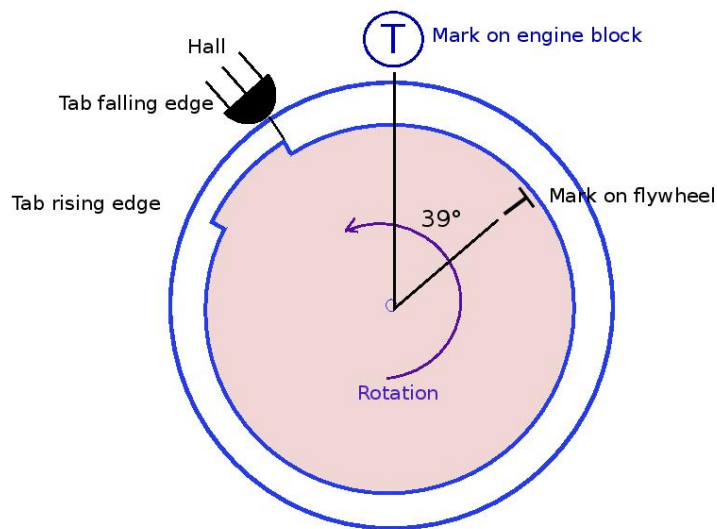

Method N°2 Engine at TDC

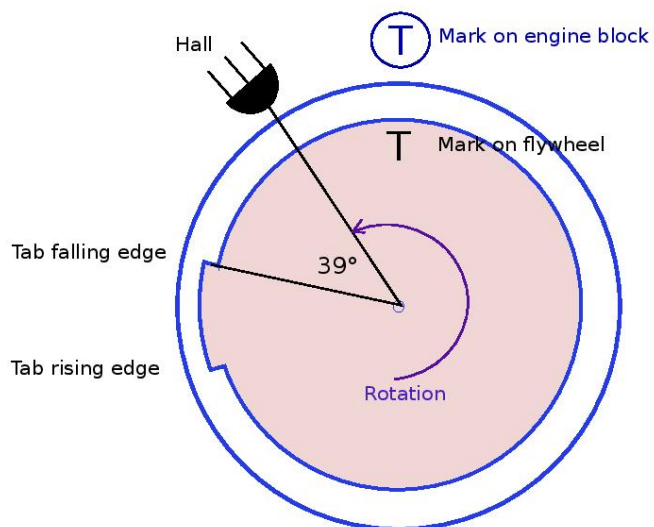

Appendix 3

A) Remove the sparkplug, find the TDC position with a *dial indicator gauge* or a *caliper rule*:



B) Align the pickup with the beginning of the magnet on the rotor and measure the travel of the piston with the caliper rule:



C) Use an online timing calculator to convert millimeters into degrees:

<https://lambretta-images.com/tuningh/port-timing-calculators/degrees-to-mm-timing-calculator/>

or

<http://www.ajcshop.fr/Calculettes/html/calculette-convertisseur-allumage.htm>

ie:

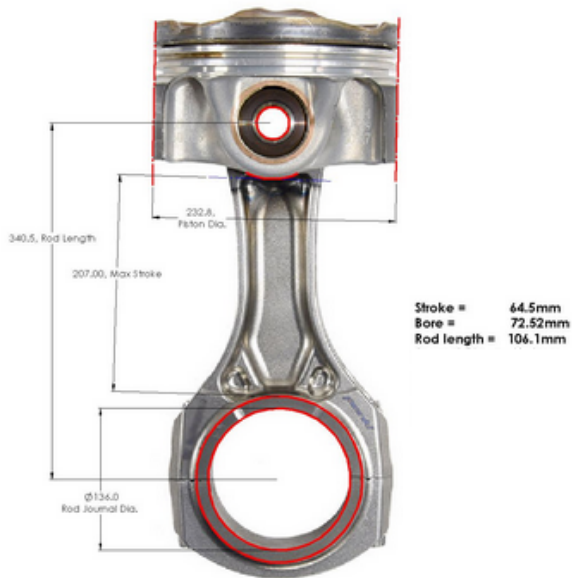

=>

1	->	64.5	Course en mm
2	->	106.1	Longueur de bielle (entraxe) en mm
3	->		Diamètre (D) du volant en mm (uniquement)
4	->	0.67	Avance en mm
Calculer		10.25	Avance en degrés (angle α) (renseigner 1, 2, 4) <u>Le résultat est en ° et centièmes de °</u>

Appendix 4

Trial and error plus Timing Lamp



If there is no mark on the flywheel, a possible way is as follows:

Method:

Remove the spark plug, insert a gauge in the sparkplug hole.
Turn the flywheel until the piston is at TDC. Remove the gauge.

Draw 2 marks opposite each other on the flywheel and on the engine case. It's the TDC mark.

Print a *Timing Tape* from <https://www.blocklayer.com/timing-tape>
Align the 0 mark to the new TDC mark and stick the tape on the flywheel.

Set the ignition box with a pickup position of say 30° BTDC

Set the ignition box with a SAFE and FLAT timing curve at a static advance (ie : 10° BTDC from 500 to 4000rpm)

Put back the sparkplug and start the engine if possible
Otherwise plug the sparkplug in it's cap, tied the plug to the frame to have sparks, then rotate the engine with a drill machine (the faster the better).

With a timing lamp, take note where on the timing tape the spark appends.

Take note how much "off" is the timing.

Examples :

If the timing lamp shows 15° BTDC (instead of 10°) that mean the "*Pickup Position*" is off by 5° (15°-10°).
Increase the "*Pickup Position*" by 5. Real position is not 30° but $30° + 5° = 35°$
Set the ignition box with a pickup position of 35° BTDC
Using the timing lamp, check that the timing is now read at 10°
Make small adjustment to the pkp position if necessary.

If the timing lamp shows 5° BTDC (instead of 10°) that mean the "*Pickup Position*" is off by -5° (5°-10°).
Lower the "*Pickup Position*" by 5. Real position is not 30° but $30° - 5° = 25°$
Set the ignition box with a pickup position of 25° BTDC
Using the timing lamp, check that the timing is now read at 10°
Make small adjustment to the pkp position if necessary.

In one word:

If the Timing Lamp measure MORE advance than what is set in the user interface then INCREASE the "*Pickup position*"

If the Timing Lamp measure LESS advance than what is set in the user interface then LOWER the "*Pickup position*"