

Summary

WIRING.....	2
Connector.....	3
KILL SWITCH.....	4
Setup Mode.....	5
Ignition Timing.....	8
Pickup Type.....	9
VR Pickup.....	10
Hall Sensor.....	11
Points.....	14
Pickup Position.....	15
Shaft.....	16
Advance Timing.....	17
Pickup Polarity.....	18
Dwell.....	19
Select curve.....	20
Read.....	21
Dump.....	22
Modification.....	23
Add points.....	24
Clear points.....	25
Clear Timing.....	26
Clear All.....	27
Factory Restore.....	28
Advanced settings.....	29
Advance at kick start.....	29
AutoSpark.....	30
Bypass.....	31
Console.....	32
Troubleshooting.....	34
Running Mode.....	35
Appendix 1.....	36
Appendix 2.....	37
Appendix 3.....	38
Appendix 4.....	41

WIRING

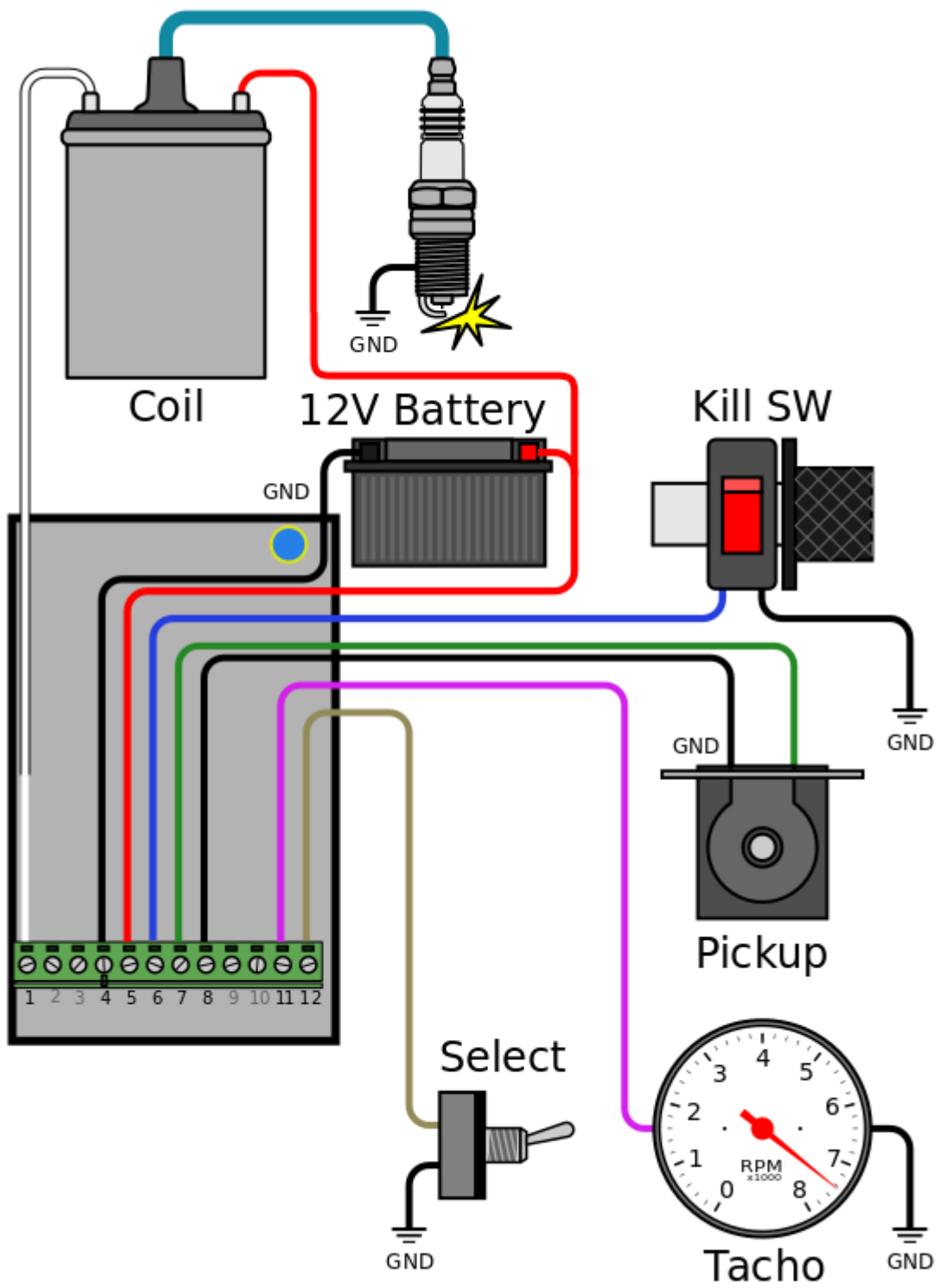

Connector



1	output	To ignition coil
2	output	<i>not connected</i>
3	input	<i>not connected</i>
4	input	Ground frame (=minus from battery)
5	input	+12Vdc from battery
6	input	Kill switch
7	input	Analog Pickup
8	input	Pickup or Hall Sensor Ground
9	input	Digital Hall Effect Sensor *
10	input	<i>not connected</i>
11	output	Tachometer *
12	input	Curve Selection *

* Options

KILL SWITCH

The ignition uses the Kill switch input as a selector between 2 functions:

- Setup

- Stop engine.

Setup Mode

1) Turn the **Kill Switch ON** (*connector pin 6 connected to ground*) **PRIOR** to power on the ignition box.

2) **Power on** the ignition box with a 6 to 12v battery.

Warning: The Power and Ground connections **MUST BE SECURE.**

A power outage during the setup process may cause the ignition box to brick !

When the ignition box detects that the kill switch is already grounded, it turns into SETUP Mode.

3) The **Blue Led** blinks 5 times then flash every 5 seconds.

4) The ignition box starts a **WiFi AP** (*Access Point*)

5) On your phone, laptop, PC, whatever, go to the **Wifi setting** and search for a new SSID called **Transmic_ign**

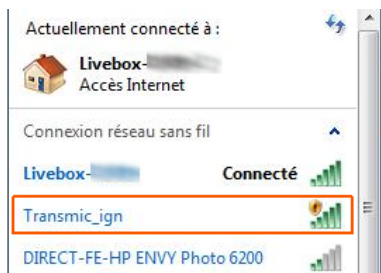

6) **Connect** to it (*there is no password*)

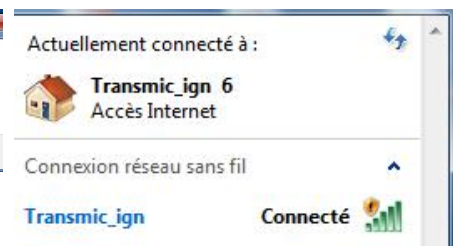
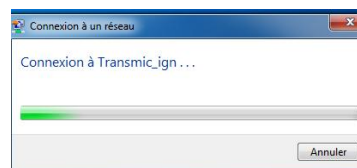

8) Once your device is connected to the AP, open up a **browser** and head over to <http://192.168.4.1/> (http not https !)

9) Once connected your browser should display:

TRANSMIC.FR

TCI V12R0C0

You are now connected
to your ignition box.

Options: 5
Serial: 2301 ©

[Configuration](#)

10) Turn the **Kill Switch OFF** for Running mode.

Troubleshooting WiFi connection

- Ignore any browser message saying it's not connected to internet:



Indeed, it's connected ONLY to the Ignition box, not to the web.

(It's impossible to reach Google and the ignition box at the same time)

- You can see available SSID with a Wifi Analyzer as [NetSpot for Android](#) or [Wifi-Analyzer for W10](#)

- You can test the network connection from your laptop to the ignition box:

Open a command Prompt:

Type "cmd" into the address bar of File Explorer and hit Enter

or Press Windows+R to open "Run" box. Type "cmd" and then click "OK"

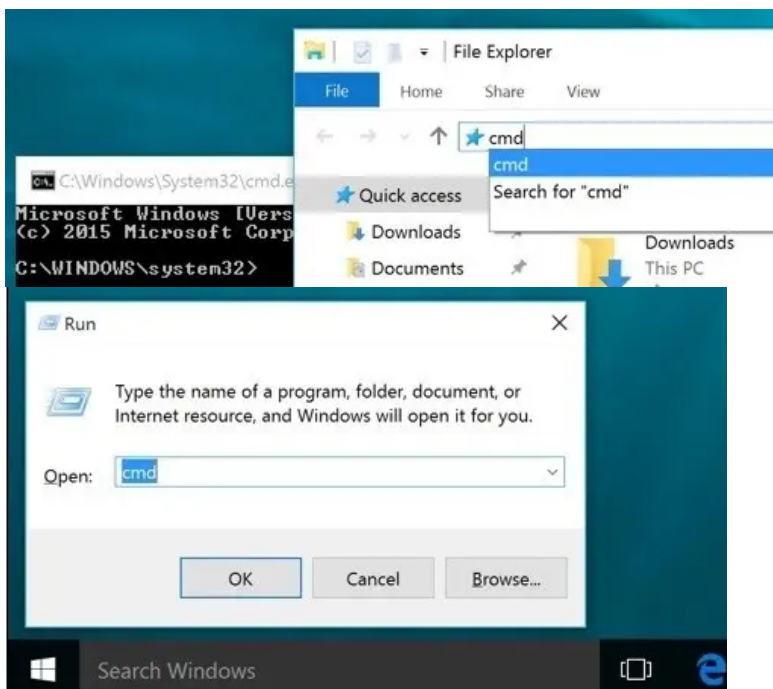

ping the ignition box, it should replies:

C:\>ping 192.168.4.1

Pinging 192.168.4.1 with 32 bytes of data :

Reply from 192.168.1.1 : bytes=32 time<1ms TTL=64

Reply from 192.168.1.1 : bytes=32 time<1ms TTL=64

Reply from 192.168.1.1 : bytes=32 time<1ms TTL=64

Clear DNS cache

Windows: in MsDos console: C:\>**ipconfig /flushdns**
MacOS: in Terminal : **sudo dscacheutil -flushcache**
Linux: in Terminal: **sudo systemd-resolve --flush-caches**

Troubleshooting display

Console URL is <http://> NOT <https://> but some browsers like Chrome automatically switch to secure <https://>

- Use Firefox. Close all Firefox windows than relaunch it.

- Use a lightweight, portable browser as [QtWeb](#)

- In Chrome, [disable HSTS](#)

Ignition Timing

Assuming you want this ignition curve:

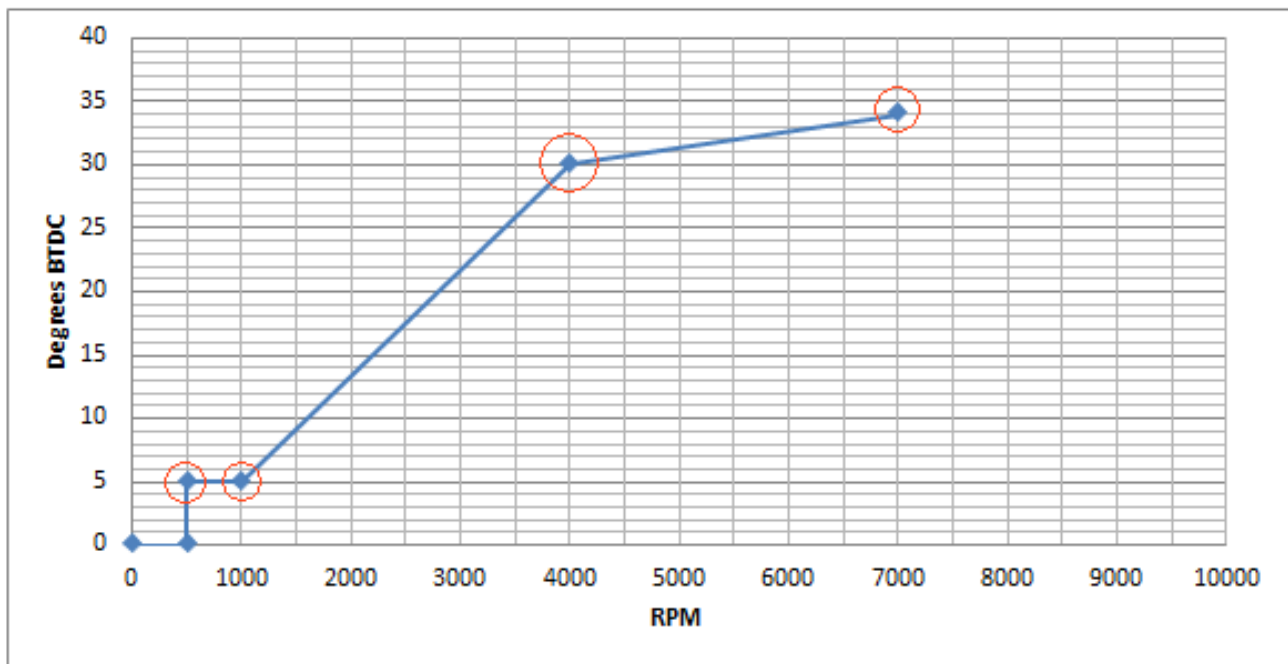

One can define this curve with 4 points but you can use up to 13 points.

0 to 500rpm at 0° BTDC is hard coded for no kickback.

The curve above is defined by 4 pairs of values

500 rpm	=	5° BTDC
1000 rpm	=	5° BTDC
4000 rpm	=	30° BTDC
7000 rpm	=	34° BTDC

Those 4 couples of values MUST be filled out in the form consecutively and in ascending order of RPM along with the pickup position.

Pickup Type

Default: 0

Select the type of pickup attached to the CDI.

MENU	PICKUP TYPE	PICKUP POSITION
STROKES	SHAFT	CYLINDERS
ADVANCE TIMING N°1	ADVANCE TIMING N°2	
ADVANCE 0-500rpm	AUTO SPARK	KICSP
DCCDI	CONSOLE	MODIFY

[0]

- 0: Analog Pickup Coil (VR)
- 1: Digital Hall Effect Sensor *

Send

** option*

0 = VR stands for Variable Reluctor aka pickup coil (Analog signal)
1 = Hall Effect Sensor (Digital signal)

VR Pickup

Analog VR pickup is connected between pins 7 and 8(gnd)

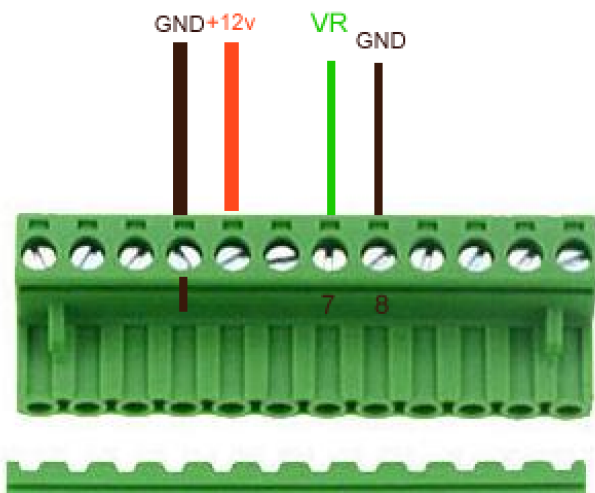

The pickup coil **MUST** be connected in order to send a **POSITIVE PULSE FIRST**:

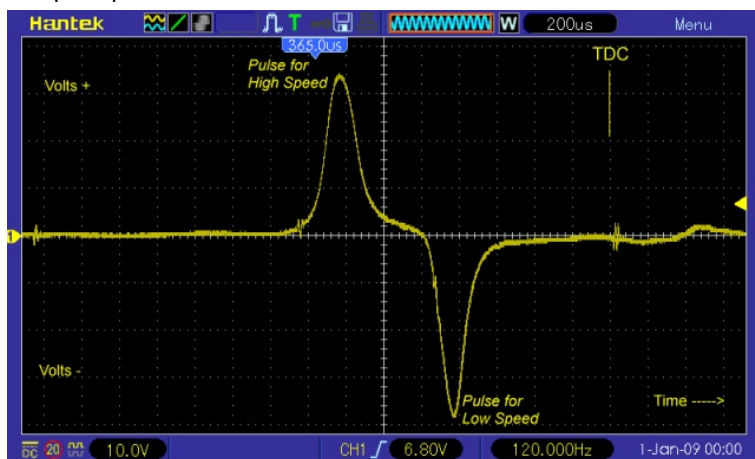

If the first pulse is Negative then the timing will be completely off (spark AFTER TDC).

Just [swap the wires](#) to change the polarity!

To avoid ElectroMagnetic Interference (EMI) it's safer to connect the pickup sensor through a shielded cable. Shield grounded on one side only.

Twisted pair is better.

Hall Sensor

A **Hall Sensor** can be connected between **pins 9 and 8(gnd)**

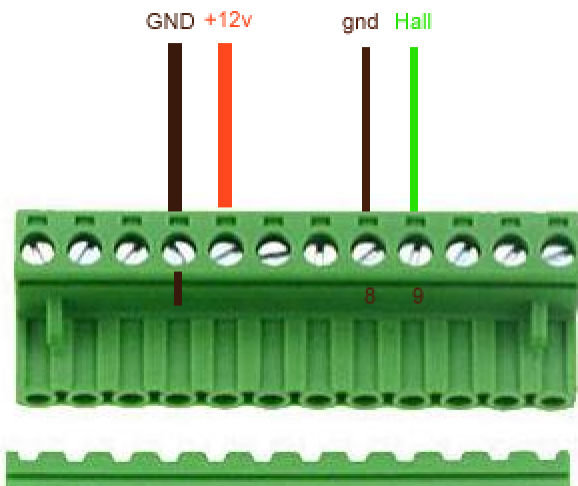

[Pickup Polarity](#) must be set to [1] for use of a Hall sensor.

2 types of Sensors

- Hall sensors with **open-collector** output, give a floating voltage when no magnet. They need a pull-up resistor.

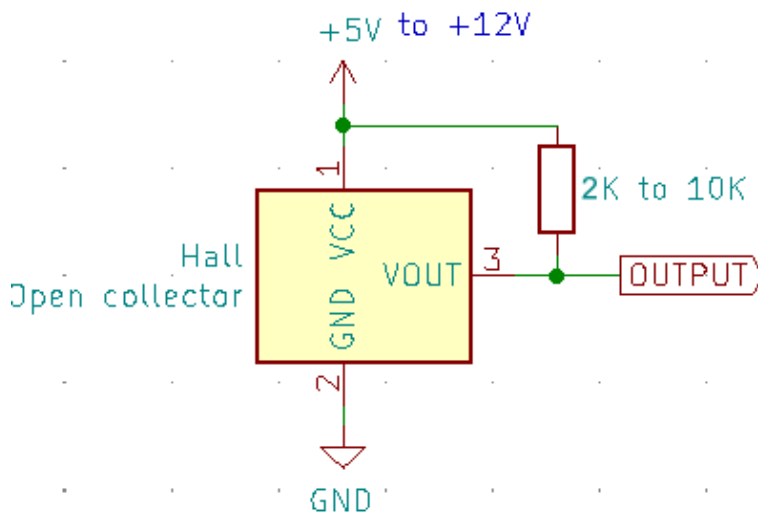

- Hall sensors with **built-in pull-up resistor** give positive voltage when no magnet.

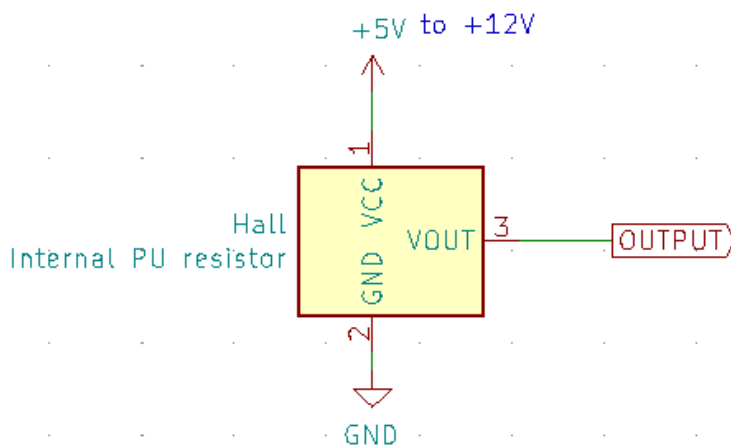

Hall sensors require a +5V to +12Vdc supply voltage.

You can even connect an **Optical Sensor** as long as it puts out a **CLEAN square signal** similar to the one above.

See [Appendix 2](#) for Position

Output of a Hall sensor

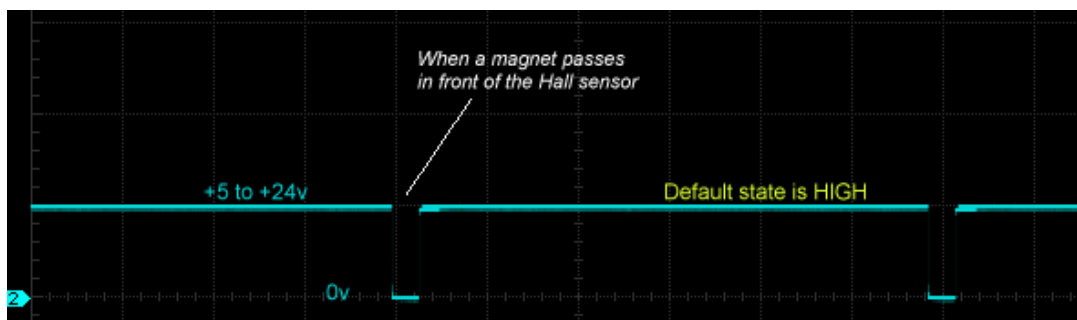

Timing

The ignition box uses the **rising edge** of the Hall sensor signal.



You can even connect an **Optical Sensor** as long as it puts out a **CLEAN** square signal similar to the one above.

Points

Points can be connected between pins 9 and 8(gnd)

First step:

Modify the wiring:

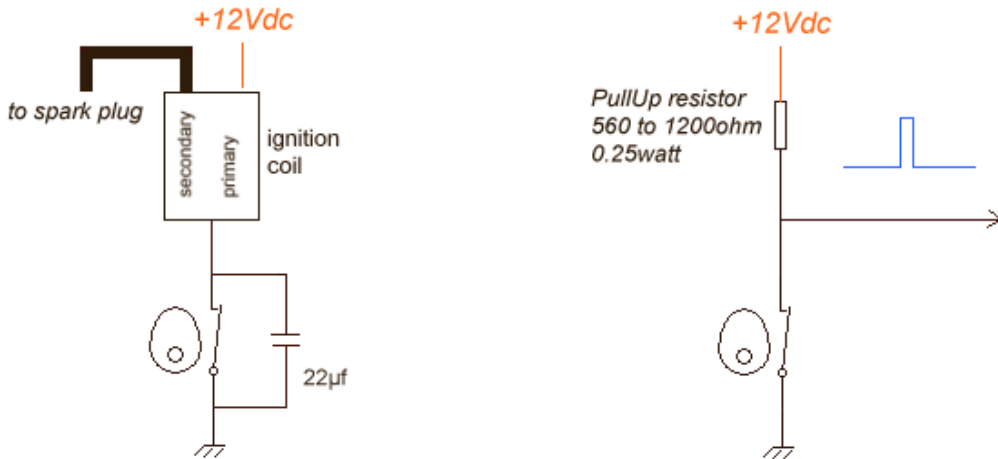

Second step:

Most conventional points have a mechanical advance with weights that change the timing depending on RPM. Now that TCI will be controlling the timing, you will need to lock out these mechanism.

2 possibilities:

A) You move the points or lock the mechanical timing to the **farthest advanced position**.

ie: If the mechanical system can shift the points until 30° BTDC. lock the points in this position and tell the TCI : "Pickup Position is 30°"

B) If Points don't have mechanical system or if you choose to lock the mechanical system for NO advance, then tell the TCI "Pickup Position is at TDC" by entering 360°

Pickup Position

Default: 50

Range of values: 1 to 360

- Go back to the browser and first thing first, enter the **Pickup Position** then click **Send**

Formula is: **Pickup position = Base advance + Magnet Length**

Magnet Length:



See [Appendix 1,2,3](#) to find the physical position of the pickup relative to TDC.

MENU	PICKUP TYPE	PICKUP POSITION
ADVANCE TIMING N°1	SHAFT	ADVANCE 0-500rpm
ADVANCE TIMING N°2	DWELL	AUTOSPARK
CONSOLE	BYPASS	MODIFY

[50]

BTDC

45

Send

- The **blue Led flashes** when value is processed.

Current value appears in blue on the form.

Shaft

Default: 0

ADVANCE TIMING N°1	SHAFT	ADVANCE 0-500rpm
ADVANCE TIMING N°2	DWELL	AUTOSPARK
CONSOLE	BYPASS	MODIFY

[0]

- 0: CrankShaft
- 1: CamShaft

Send

- Select if the pickup is placed on the crankshaft via the flywheel (2stk,4stk) with 1 pulse per rotation or is on the camshaft (4stk) with 1 pulse per 2 rotations.

Current value appears in blue on the form.

Advance Timing

- Proceed now to enter the advance timing.

We want to setup:

500 rpm = 5° BTDC
1000 rpm = 5° BTDC
4000 rpm = 30° BTDC
7000 rpm = 34° BTDC

Enter values consecutively in ascending order of RPM !

Pair 500:5 first etc etc...

7000 being the last value (as the firmware stops reading when it meets a null value),

7000 will act as the hard rev-limiter: No more sparks at 7001 RPM !

MENU PICKUP TYPE PICKUP POSITION
ADVANCE TIMING N°1 SHAFT ADVANCE 0-500rpm
ADVANCE TIMING N°2 DWELL AUTOSPARK
CONSOLE BYPASS MODIFY

Curve N°1

[500rpm => 5°]
[2000rpm => 15°]

RPM

3000

ADV

14

Send

Stored Values:

Timing Curve 1:

0	500
4	5
8	1000
12	5
16	3000
20	40
24	8000
28	30
32	0
36	0
40	0
44	0

RPM can be entered with a 100rpm step but RPM will be measured with **1rpm** precision.

Timing can be entered with a precision of 1° but the processor calculate all timing values between the points you entered using linear interpolation so an **accuracy of 0.1°** is done at this step.

Any timing values will be **COMPLETELY OFF** IF PICKUP POSITION IS FALSE: **PICKUP POSITION IS KEY**

See [Appendix 1](#) for Position

Curve N°1 is stored at addresses 0 to 100

Pickup Polarity

Default: 0

MENU	PICKUP TYPE	PICKUP POSITION
ADVANCE TIMING N°1	SHAFT	ADVANCE 0-500rpm
ADVANCE TIMING N°2	DWELL	AUTOSPARK
CONSOLE	BYPASS	MODIFY

[0]

- 0: Analog Pickup Coil (VR)
- 1: Digital Hall Effect Sensor *

Send

** option*

Current value appears in blue on the form.

When the LEADING edge of the magnet passes in front of the pickup coil, a wave is produced and another wave of opposite voltage is generated when the FALLING edge of the magnet leaves the pickup coil.

Depending on the wiring, the first pulse at Leading Edge can be positive (then negative at Falling edge), or the exact opposite.

Pickup Polarity MUST be Positive then Negative to work with this TCI

Like that:

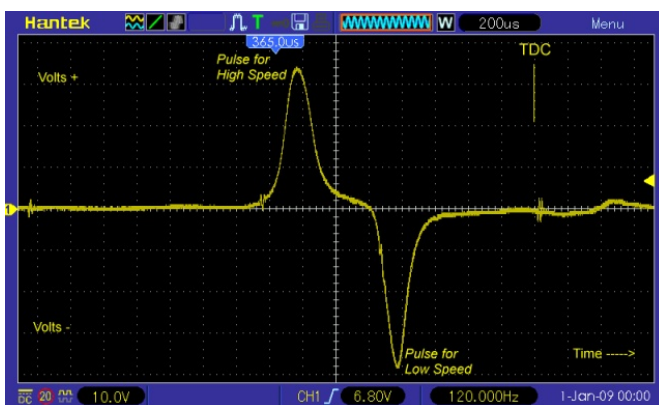

Dwell

Default: 3

Range of values: 1 to 6

Dwell time is the charge time for the ignition coil.

It vary with different types of ignition coil and is typically 2 milliseconds for many modern coils and 4 or 5 milliseconds for older ignition coils.

Spark appends when the current flow is stopped **after** Dwell time.

ADVANCE
TIMING N°2

DWELL

AUTOSPARK

CONSOLE

BYPASS

MODIFY

[3]

3ms

Send

Current value appears in blue on the form.

Keep in mind that the longer the Dwell time, the lower the max RPMs

Select curve

Default: curve N°1

If you bought the 2 curves option, then connect a switch between connector **pin 12 and ground**.

When switch is **open** (or no switch connected), **curve N°1** will be used.

If switch is **on** (pin 12 connected to ground) BEFORE turning on the ignition box, then **curve N°2** will be used.

You cannot change the curve while running.

ADVANCE
TIMING N°2

DWELL

AUTOSPARK

CONSOLE

BYPASS

MODIFY

Curve N°2 *

RPM

ADV

** option*

96	0
100	0
Timing Curve 2:	
104	501
108	5
112	1001
116	8
120	3001
124	30
128	10001
132	40
136	0
140	0
144	0
148	0
152	0
156	0
160	0
164	0
168	0
172	0
176	0
180	0
184	0
188	0
192	0
196	0
200	0
204	0

Settings:

Curve N°2 is stored at addresses 104 to 204

Read

- To display the values that have been set, click on the **Read** button on the **Home** page :

MENU PICKUP TYPE PICKUP POSITION

STROKES SHAFT CYLINDERS

ADVANCE TIMING N°1 ADVANCE TIMING N°2

ADVANCE 0-500rpm AUTO SPARK KICSP

DCCDI CONSOLE MODIFY

Read Dump

Clear Timing Clear All

Factory Restore Home

Stored Values:

Timing Curve:

0	500
4	5
8	1000
12	5
16	4000
20	30
24	7000
28	34
32	0
36	0
40	0
44	0
48	0
52	0
56	0
60	0
64	0
68	0
72	0
76	0
80	0
84	0
88	0
92	0
96	0
100	0

exit



Stored Values:

Timing Curve:

0	500
4	5
8	1000
12	5
16	4000
20	30
24	0
28	0
32	0
36	0
40	7000
44	34
48	0
52	0
56	0
60	0
64	0
68	0
72	0
76	0
80	0
84	0
88	0
92	0
96	0
100	0

exit



204 0

Settings:

208	0	Autospark (TCI)
212	0	Pickup Type
216	50	Pickup Position
220	0	DwellType (TCI)
224	3	Dwell (TCI)
228	0	Console output
232	0	Bypass (TCI)
236	0	Adv 0-500rpm
240	0	
247	0	Shaft
248	5	Starts

Home

Dump

Read EEPROM addresses and display them in HEX values for debug purpose.

MENU	PICKUP TYPE	PICKUP POSITION
STROKES	SHAFT	CYLINDERS
ADVANCE TIMING N°1	ADVANCE TIMING N°2	
ADVANCE 0-500rpm	AUTO SPARK	KICSP
DCCDI	CONSOLE	MODIFY

Read	Dump
------	------

Clear Timing	Clear All
--------------	-----------

Factory Restore	Home
-----------------	------

Dump EEPROM Hex Values:

0	F4	01	00	00	05	00	00	00
8	40	1F	00	00	28	00	00	00
16	34	21	00	00	28	00	00	00
24	00	00	00	00	00	00	00	00
32	00	00	00	00	00	00	00	00
40	00	00	00	00	00	00	00	00
48	00	00	00	00	00	00	00	00
56	00	00	00	00	00	00	00	00
64	00	00	00	00	00	00	00	00
72	00	00	00	00	00	00	00	00
80	00	00	00	00	00	00	00	00
88	00	00	00	00	00	00	00	00
96	00	00	00	00	00	00	00	00
104	00	00	00	00	00	00	00	00
112	00	00	00	00	00	00	00	00
120	00	00	00	00	00	00	00	00
128	00	00	00	00	00	00	00	00
136	FE	00	00	00	00	00	00	00
144	00	00	00	00	00	00	00	00
152	00	00	00	00	00	00	00	00
160	00	00	00	00	00	00	00	00
168	00	00	00	00	00	00	00	00
176	00	00	00	00	00	00	00	00
184	00	00	00	00	00	00	00	00
192	00	00	00	00	00	00	00	00
200	00	00	00	00	00	00	00	00
208	00	00	00	00	00	00	00	00
216	32	00	00	00	00	00	00	00
224	02	00	00	00	00	00	00	00
232	00	00	00	00	00	00	00	00
240	00	00	00	00	01	00	00	00

Home

Modification

LINE

NEW VALUE

Say you want to modify the advance timing for 7000rpm and set 35° instead of 34°

In *Read* mode above, we saw that RPM 7000 is stored at address 24 and timing for 7000rpm is at address 28.

24	7000
28	34
32	0

Since we want to modify the advance timing at line 28, we now have to enter :

Line **28**
New value **35**
then **Send**

LINE

NEW VALUE

Same thing to change any other values.

Remember: **All timing values must be in ascending order of RPM !**
Use *Read* button to check that.

Add points

Say you want **to add** one advance timing of 34° @ 8000rpm

In *Read* mode above, we saw that last RPM 7000 is stored at address 24 and timing for 7000rpm is at address 28.

The next 2 **empty** slots available are:

24	7000
28	34
32	0
36	0
40	0

Address **32** for RPM and Address **36** for timing

We now have to enter :

Line **32**
New value **8000**
then **Send**

Line **36**
New value **34**
then **Send**

Remember: All timing values must be in ascending order of RPM !
Use *Read* button to check that.

Clear points

Say you want to remove the last advance timing of 34° @ 7000rpm

In *Read* mode above, we saw that last RPM 7000 is stored at address 24 and timing for 7000rpm is at address 28.

24	7000
28	34
32	0
36	0
40	0

To zero out those values we now have to enter :

Line **24**
New value **0**
then **Send**

Line **28**
New value **0**
then **Send**

Remember: All timing values must be **consecutive** and in **ascending** order of RPM !
Use *Read* button to check that.

Stored Values:

Timing Curve:

0	500
4	5
8	1000
12	5
16	4000
20	30
24	0
28	0
32	0
36	0
40	7000
44	34
48	0
52	0
56	0
60	0
64	0
68	0
72	0
76	0
80	0
84	0
88	0
92	0
96	0
100	0



exit

Clear Timing

This button will **clear TIMING values** WITHOUT confirmation.

Pickup position, polarity, shaft, dwell etc are kept.

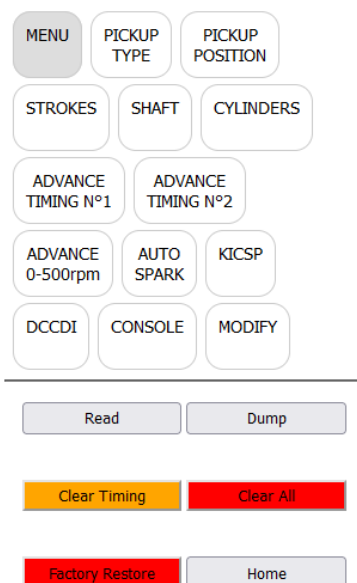

Browser shows :

Timing values cleared!

Please restart the ignition box.

This box now has no Advance Curve and cannot operate until you set timing values.

Restart the ignition box. (power off/power on)

Don't forget the Kill switch position if you want to return in Setup mode....

Clear All

This button will **clear ALL values** WITHOUT confirmation.

Timing, Pickup position, polarity, shaft, dwell etc are zeroed.

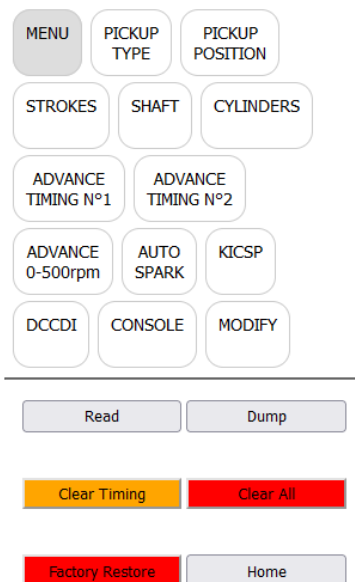

Browser shows :

EEPROM values cleared!

Please restart the ignition box.

This box is now empty and cannot operate until you set values. '

Restart the ignition box. (power off/power on)

Don't forget the Kill switch position if you want to return in Setup mode....

Factory Restore

This button will **Restore Factory Default** WITHOUT confirmation.

Timing, Pickup position, polarity, shaft, dwell etc are set to default values.

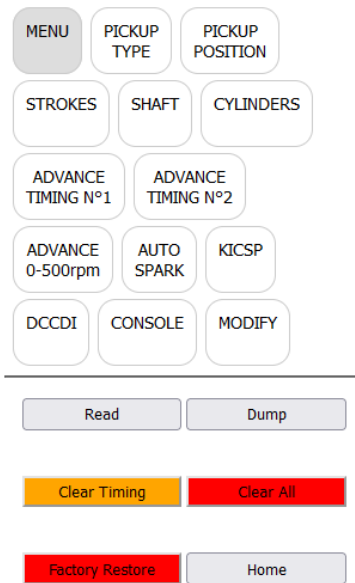

Browser shows :

Init All done!

**This box now have a default Advance Curve which is not the one you need...
Tune the values before to start the engine!**

Restart the ignition box. (power off/power on)

Don't forget the Kill switch position if you want to return in Setup mode....

Advanced settings

If you don't need those Extra settings, just let them to their default value.

Advance at kick start

Default: 0

Range of values: 0 to 10

For an easier Manual Kick start and to avoid kick backs, you can delay the advance between 0 to 500rpm to send the spark a few degrees **After** Top Dead Center (ATDC)

ADVANCE TIMING N°1	SHAFT	ADVANCE 0-500rpm
ADVANCE TIMING N°2	DWELL	AUTOSPARK
CONSOLE	BYPASS	MODIFY

[0]

ATDC

Send

Current value appears in blue on the form.

AutoSpark

Default: Off

Range of values: Off, 300 1000, 3000, 10000rpm

This **autotest function** is usable on TCI and DCCDI only.

The ignition box fires the ignition by itself at 300/1000/3000/10000rpm WITHOUT any pickup connected.

This way you can test the wiring, the TCI/DCCDI, the ignition coil and sparkplug.

Of course, remove the sparkplug from the cylinder head and connect the metal part to the frame.

ADVANCE TIMING N°2	DWELL	AUTOSPARK
CONSOLE	BYPASS	MODIFY

[0]

- 0: Off
- 1: 300rpm
- 2: 1000rpm
- 3: 3000rpm
- 4: 10000rpm

Send

Current value appears in blue on the form.

Bypass

Default: Off

This function bypass the advance timing and trigger a spark AS SOON AS a pickup pulse has been detected.

This function comes handy when you want to know the pickup position with a Timing Lamp :

Remove the sparkplug out of the engine and connect it to the metal frame, then rotate the engine with a drill machine.

With points and mechanical advance system, TCI in Bypass mode is acting as a simple Transistorized Ignition.

/!\ Don't use the function on a running engine fitted with pickup or hall sensor otherwise the spark will append way too soon and can harm the piston !!

CONSOLE

BYPASS

MODIFY

[0]

0: Off

1: On

Send

Current value appears in blue on the form.

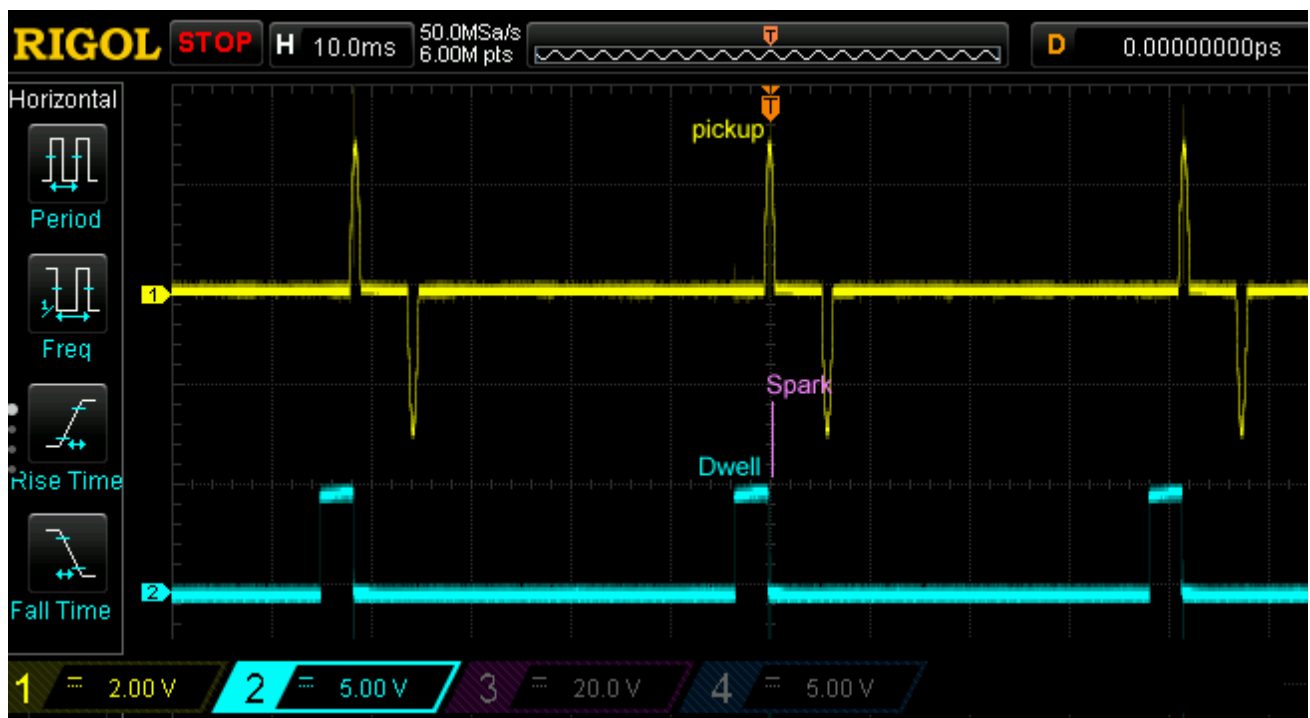

Console

Default: Off

Enable the Console output:

- Turn the ignition box in [Setup Mode](#)
- Go to "**CONSOLE**", check "1" to enable the console output, press Send

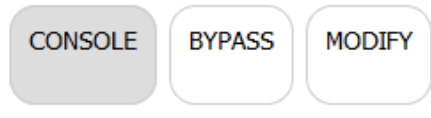

[0]

- 0: Off
- 1: On

Send

Current value appears in blue on the form.

- Power **off** the ignition box
- **Disconnect** the **Kill** wire from ground
- 1) **Power on** the ignition box, it goes in "**Run Mode**"
- 2) The **blue LED** flashes once if curve N°1 is selected or flashes twice for curve N°2
- 4) The ignition box also creates a **WiFi AP** (*Access Point*)
- 5) On your phone, laptop, PC, whatever, go to the **Wifi setting** and search for a new SSID called **Transmic_ign**
You can see available SSID with a Wifi Analyzer as [NetSpot for Android](#) or [Wifi-Analyzer for W10](#)

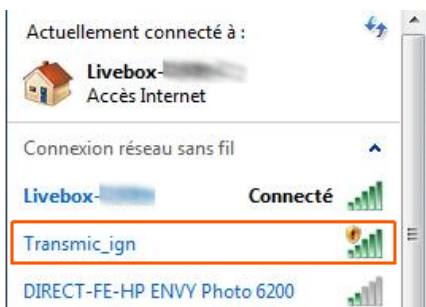

6) **Connect** to it (*there is no password*)

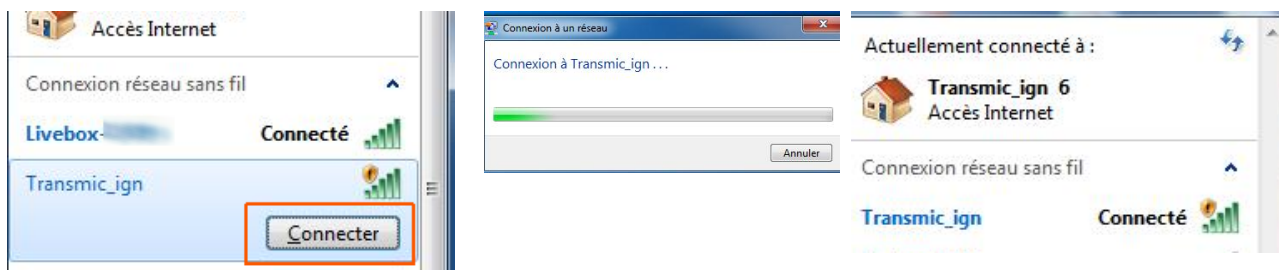

7) **Start** the engine

8) Once your device is connected to the AP, open up a **browser** and head over to <http://192.168.4.1>

9) After a few seconds, the browser should display both the **RPM and the advance timing** in degrees BTDC followed by 2 bargraphs

RPM vs ADV

3360

39.29



Display appears ONLY when engine is running.

Troubleshooting

Console URL is `http://` NOT `https://` but some browsers like Chrome automatically switch to `https://`

Workarounds

- Use Firefox. Close all Firefox windows than relaunch it.
- Use a lightweight, portable browser as [QtWeb](#)
- In Chrome, disable **HSTS** (*HTTP Strict Transport Security*) that forces to open websites in HTTPS:
 - Write **chrome://net-internals/#hsts** in the address bar.
 - Scroll down the page to :

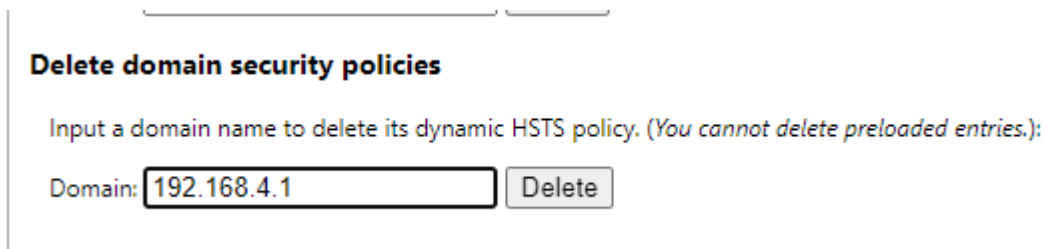

- add **192.168.4.1** and hit **Delete** to disable Force https for this particular website.

Running Mode

- 1) **Disconnect** the **Kill** wire from ground if you previously went into [Setup Mode](#)
- 2) **Power on** the ignition box, it goes in normal "**Run Mode**"
- 3) The **blue LED** stays On waiting for pickup signal.
- 4) Start the engine. The blue LED **blinks** in time **with RPM**.
- 5) When the engine runs, if **Kill** wire is connected **to ground** THEN it **stops** the engine.

*/!\ Kill the engine with the Kill switch BEFORE shutting down the +12v.
(As it's a software kill, the processor must be powered on to be able to kill the engine!)*

Appendix 1

Find the physical position of the analog **pickup** relative to Top Dead Center.

In the example below the pickup is set at 39° BTDC

Method N°1

Pickup aligned with rising edge

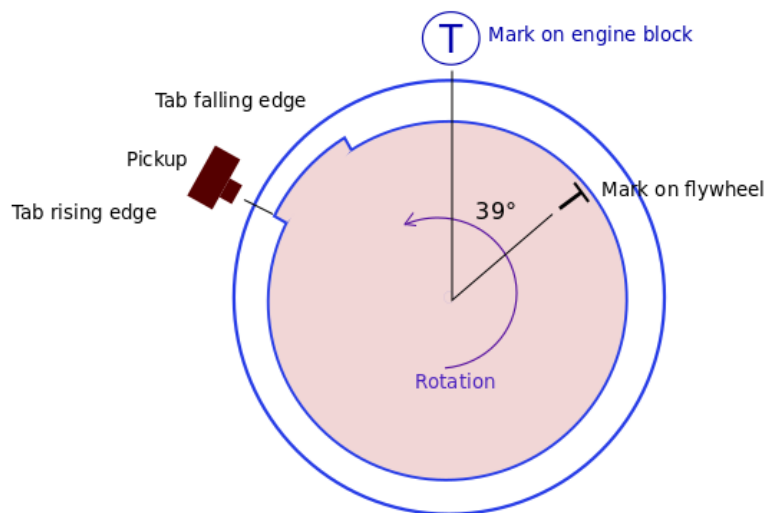

Method N°2

Engine at TDC

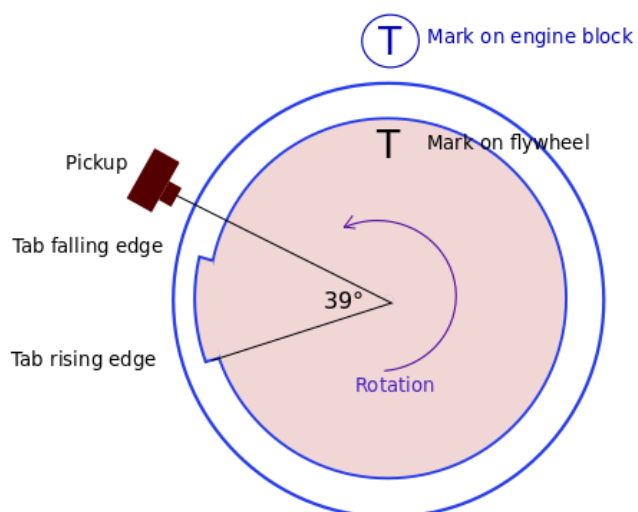

Leading|Rising edge generate pulse for high revs
Trailing|Falling edge generate pulse for idle.

Appendix 2

Find the physical position of the digital **Hall Sensor** relative to Top Dead Center.

In the example below the sensor is set at 39° BTDC

Method N°1 Hall sensor aligned with falling edge

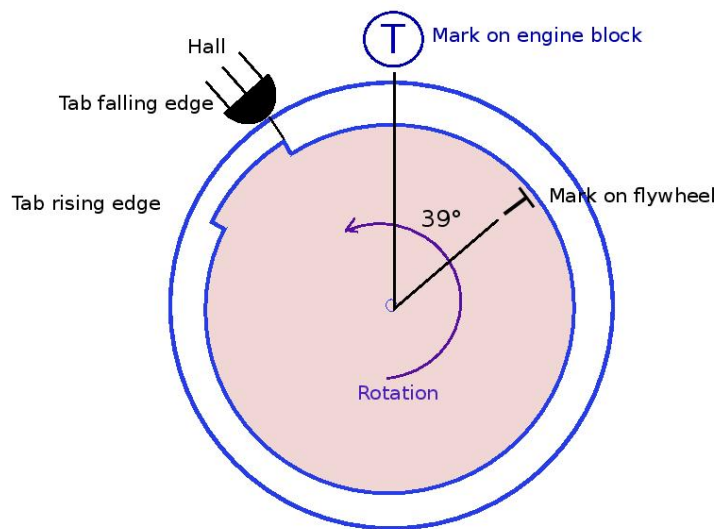

Method N°2 Engine at TDC

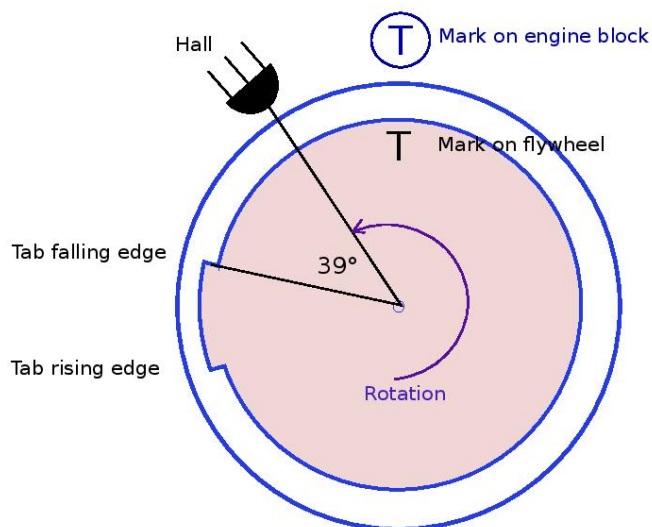

Appendix 3

A) Remove the sparkplug, find the TDC position with a *dial indicator gauge* or a *caliper rule*:



B) Align the pickup with the beginning of the magnet on the rotor and measure the travel of the piston with the caliper rule:



C) Use an online timing calculator to convert millimeters into degrees:

<https://lambretta-images.com/tuningh/port-timing-calculators/degrees-to-mm-timing-calculator/>

or

<http://www.ajcshop.fr/Calculettes/html/calculette-convertisseur-allumage.htm>

ie:

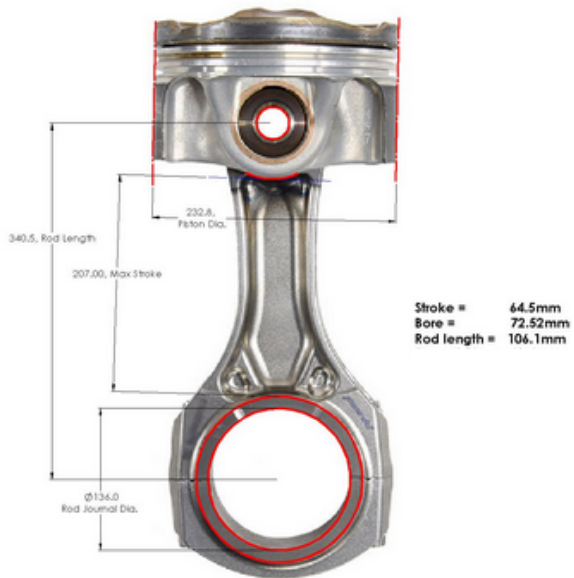

=>

1	->	64.5	Course en mm
2	->	106.1	Longueur de bielle (entraxe) en mm
3	->		Diamètre (D) du volant en mm (uniquement)
4	->	0.67	Avance en mm
Calculer		10.25	Avance en degrés (angle α) (renseigner 1, 2, 4) <u>Le résultat est en ° et centièmes de °</u>

Appendix 4

Tries and errors and Timing Lamp



First method:

For example, if you set the "Pickup position" to 40° BTDC plus some timing points then with your Timing Lamp you measure MORE advance than what is set in the user interface (ie you measure 35° instead of 30°@3000rpm) then INCREASE the "Pickup position" (40° → 45°)

If you set the "Pickup position" to 40° BTDC and with your Timing Lamp you measure LESS advance than what is set in the user interface (ie you measure 25 instead of 30°@3000rpm) then LOWER the "Pickup position" (40° → 35°)

Second method:

Set a FLAT advance timing with a SAFE value:

Example: 10° BTDC from 500 to 4000rpm

Run the bike and measure the timing with a Timing Lamp.

If you measure say 15° BTDC (instead of 10°) that mean the "Pickup Position" is off by 5°. Increase the "Pickup Position" by 5.

If you measure say 5° BTDC (instead of 10°) that mean the "Pickup Position" is off by 5°. Lower the "Pickup Position" by 5.