

Summary

Wiring.....	2
Stator.....	4
Connector.....	5
Kill Switch.....	6
Setup Mode.....	7
Troubleshooting WiFi connection.....	8
Ignition Timing.....	12
Pickup Type.....	13
Pickup voltage.....	14
VR pickup.....	15
Hall Sensor.....	16
Pickup Position.....	19
Strokes.....	20
Shaft.....	21
Advance Timing.....	22
Select curve.....	23
Read.....	24
Dump.....	25
Modification.....	26
Add points.....	27
Clear points.....	28
Clear Timing.....	29
Clear All.....	30
Factory Restore.....	31
Advanced settings.....	32
Advance at kick start.....	32
Kick Speed.....	33
Console.....	34
Troubleshooting.....	36
Running Mode.....	37
Appendix 1.....	38
Appendix 2.....	40
Appendix 3.....	41
Appendix 4.....	44

Wiring

The *charging coil* that charges the internal capacitor of this AC-CDI can be connected in two different ways:

Full-Rectification

One wire of the charging coil is connected to the connector on **pin 2 (HV input)** and the other wire goes to connector **pin 3 (HV input)**

This wiring provides an isolated ground (*stator output is not connected to the ground in any way*) and a Full Rectification that double the AC voltage.

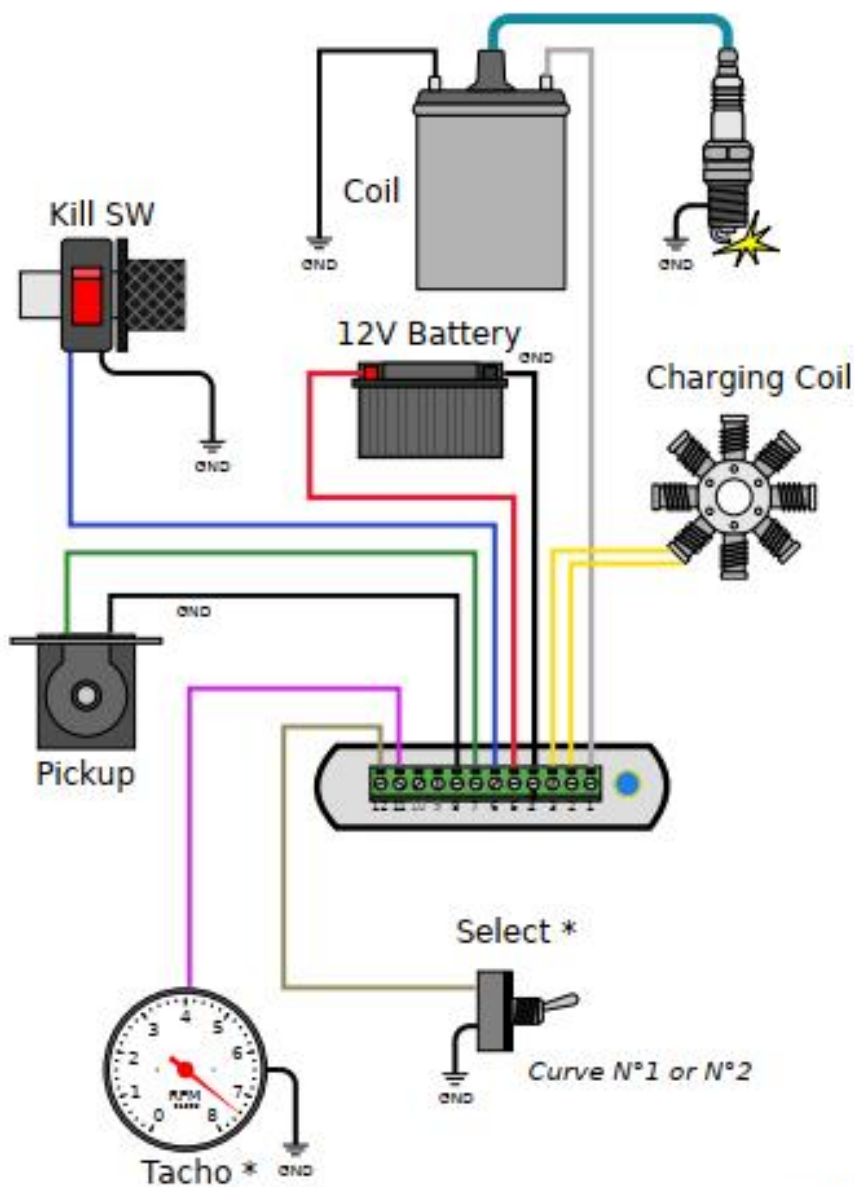
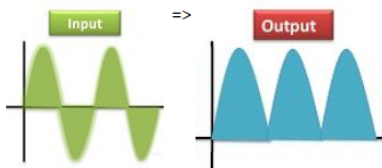

* optional

Half-Rectification

One wire of the charging coil is connected to the connector on **pin 2 (HV input)** and the other wire goes to connector **pin 4 (Ground of the AC-CDI)** or on any metal part of the frame connected to ground/minus battery

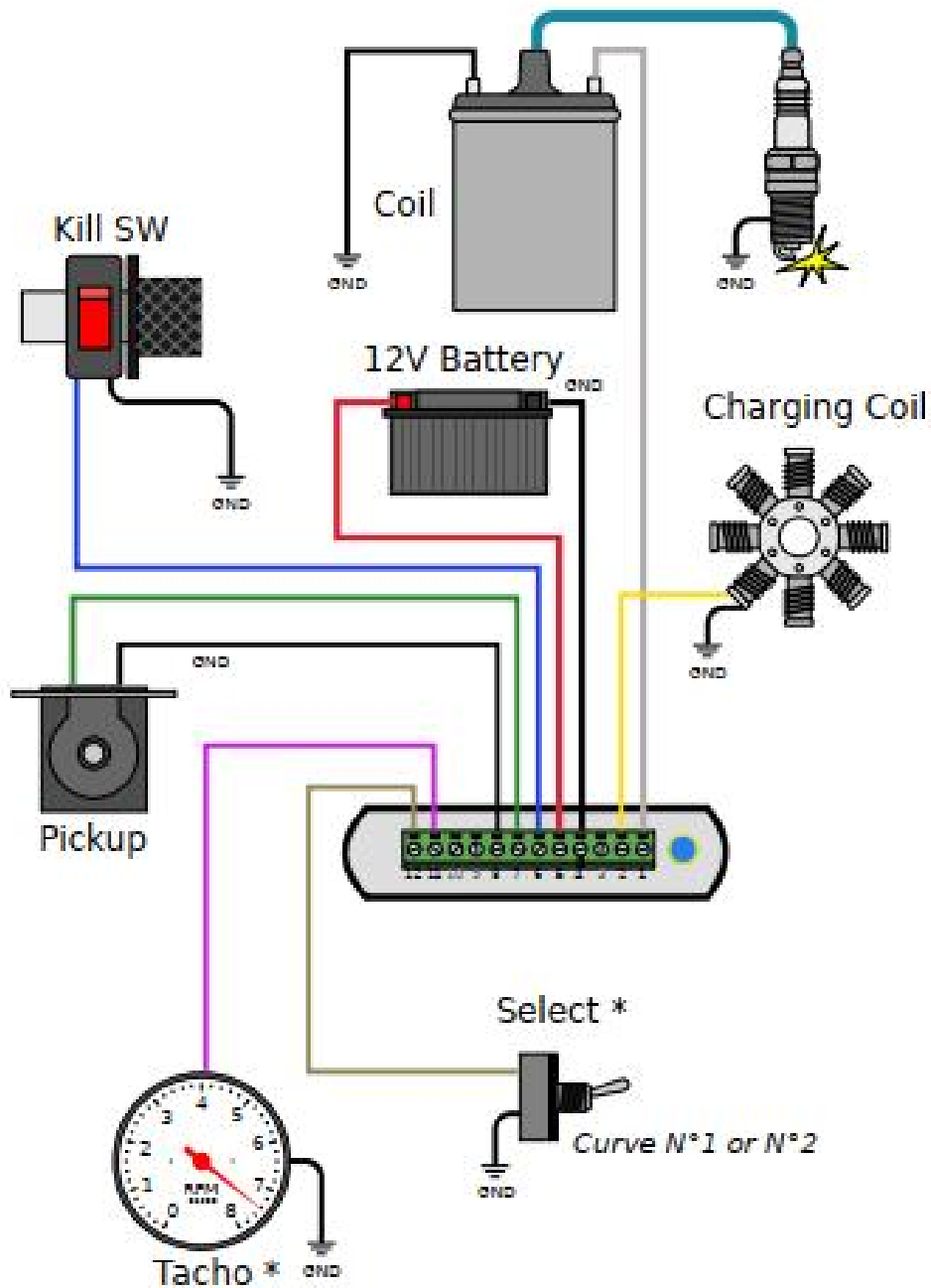
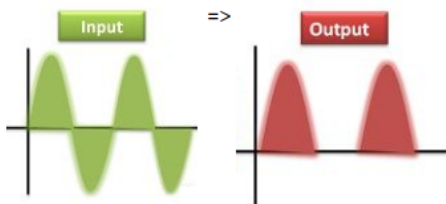

* optional

Stator

All AC-CDI need a working stator/High Voltage AC charging system.

Even if the stator passes the User Manual resistance check, only a voltage test will show if the stator is reliable throughout the rev range.

The voltage fluctuates with rpm. Check the voltage across the rpm range as well, since it should grow as the revs raise.

Voltage depend on the type of charging coils, number of coils and magnets etc...

For example, at 1500rpm, it should read approximately 30-40Vac, at 3000rpm it should read 60-80Vac, at 6000rpm 120-160vac and so on.

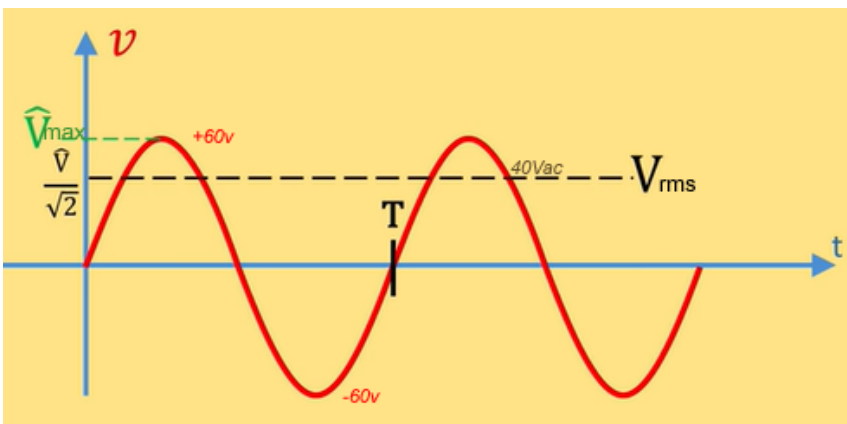

An oscilloscope will show you the peak to peak voltage.

ie: +60V max to -60v min = 120V peak to peak (120Vpp)

RMS Voltage = $V_{max} / \sqrt{2} = 60 / 1.414 = 40Vac$

The given formula only applies to pure sinus waves.

But because a stator produces a non-sinusoidal waveform, a basic Digital Multimeter will provide inaccurate readings.

Only TrueRMS Multimeters can display a stator output's RMS value. (here +40v)

Or classic multimeter with [a DVA adapter](#) will show the Vmax voltage. (here +60v)

Connector



1	output	To ignition coil
2	input	High Voltage from Charging Coil
3	input	High Voltage from Charging Coil
4	input	ground frame (=minus from battery)
5	input	+12Vdc from battery
6	input	Kill switch
7	input	Analog Pickup
8	input	Pickup or Hall Sensor Ground
9	input	Digital Hall Effect Sensor *
10	input	If second analog Pickup for Low RPM
11	output	Tachometer *
12	input	Curve Selection *

Kill Switch

The ignition uses the Kill switch input as a selector between 2 functions:

- Setup
- Stop engine.

Setup Mode

1) Turn the **Kill Switch ON** (*connector pin6 connected to ground*) **PRIOR** to power on the ignition box.

2) **Power on** the ignition box with a 6 to 12v battery.

Warning: The Power and Ground connections MUST BE SECURE.
A power outage during the setup process may cause the ignition box to brick !

When the ignition box detects that the kill switch is already grounded, it turns into SETUP Mode.

3) The **Led** blinks 5 times meaning grounded Kill switch has been detected.

Kill wire can be disconnected from the ground.

Then wait for the WiFi server to start,

then blinks 5 times again meaning "*Wifi Ready*" and finally flashes once every 5 seconds.

4) The ignition box starts a **Wifi AP** (Access Point)

5) On your phone, laptop, PC, whatever, go to the **Wifi setting** and search for a new SSID called **Transmic_ign**

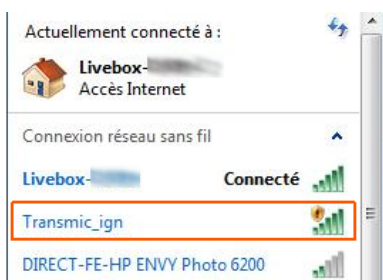

6) **Connect** to it. Password is required: it's "*password*"

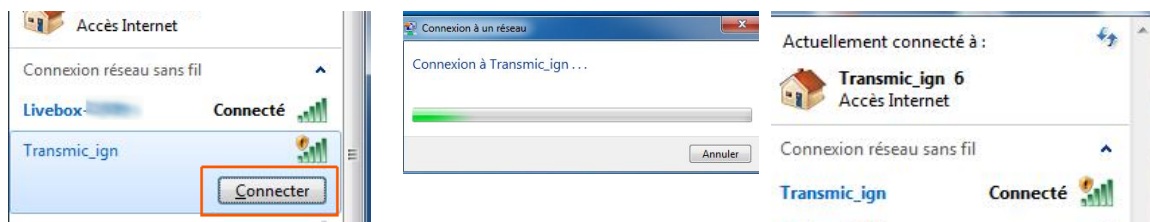

8) Once your device is connected to the AP, open up a **browser**

and head over to <http://192.168.4.1/setup> (**http not https !**)

9) Once connected your browser should display:

TRANSMIC.FR

<MODEL> <VERSION>

You are now connected
to your ignition box.
Options: 5
Serial: 2301 ©

[Configuration](#)

10) If not yet done, **turn the Kill Switch OFF** (Kill wire disconnected from the ground) **for Running mode**.

Troubleshooting WiFi connection

- Check that the 12pins connector is FULLY inserted and there is nothing preventing the male connector from fully engaging.

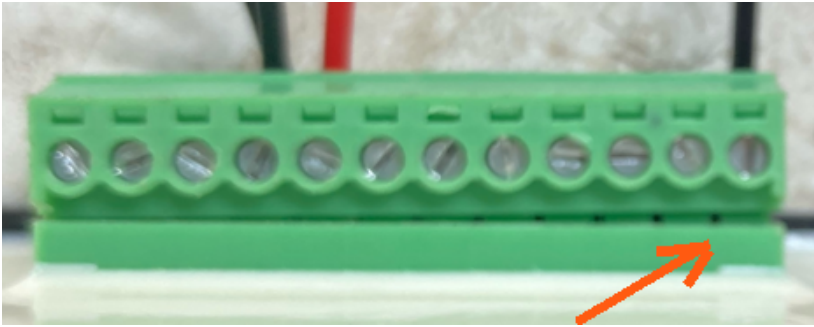

- Reboot the ignition box. (Power off/power up)

- Ignore any browser message saying it's not connected to internet. It's not an Error, it's a Warning:

ie: Firefox on W10:



Iphone11:



Indeed, **it's connected ONLY to the Ignition box, not to the web.**
(It's impossible to reach Google and the ignition box at the same time)

- You can see available SSID with a WiFi Monitor as [Wifi Analyzer for Android](#) or [Wifi-Analyzer for W10](#)

- You can test the network connection from your laptop to the ignition box:

Open a command Prompt:

Type "cmd" into the address bar of File Explorer and hit Enter or Press Windows+R to open "Run" box. Type "cmd" and then click "OK"

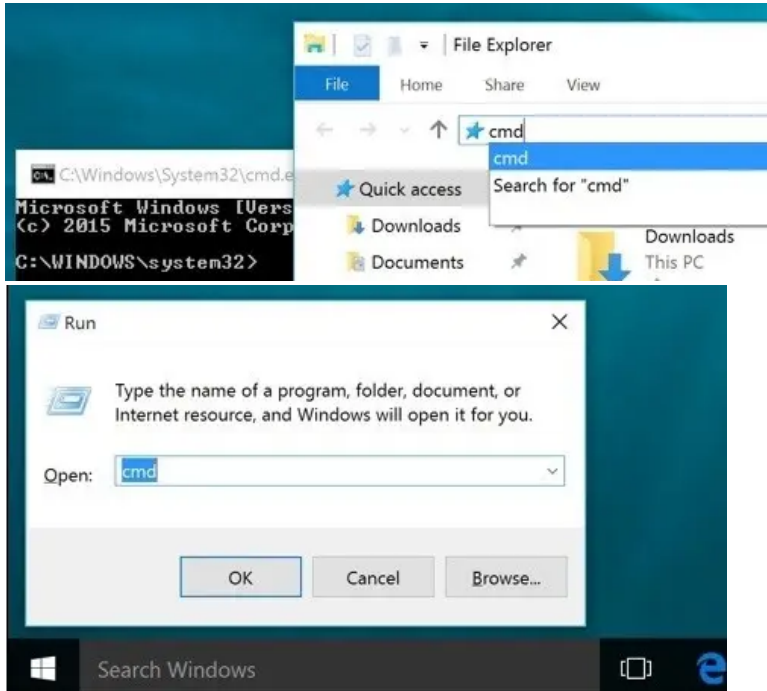

ping the ignition box, it should replies:

```
C:\>ping 192.168.4.1
```

```
Pinging 192.168.4.1 with 32 bytes of data :
```

```
Reply from 192.168.1.1 : bytes=32 time<1ms TTL=64
```

```
Reply from 192.168.1.1 : bytes=32 time<1ms TTL=64
```

```
Reply from 192.168.1.1 : bytes=32 time<1ms TTL=64
```

Clear DNS cache

Windows:	in MsDos console:	C:\> ipconfig /flushdns
MacOS:	in Terminal :	sudo dscacheutil -flushcache
Linux:	in Terminal:	sudo systemd-resolve --flush-caches

Troubleshooting display

Console URL is <http://> NOT <https://> but some browsers like Chrome automatically switch to secure <https://>

- Use Firefox. *Close all Firefox windows than relaunch it.*
- or Use a lightweight, portable browser as [QtWeb](#)
- or [disable HSTS](#) In Chrome.

iPhone won't connect to Wifi AP

Apple is full of features like probing the wifi connection by trying to connect to apple.com and rejecting the cnx if not possible, DNS probing, wifi switching, wifi assist, you name it

You may be not prompted for a password.

Apple devices try "weak" passwords in the background !

If it connected to SSID "Transmic_ign" (Check mark below) that means it guessed the right pwd.

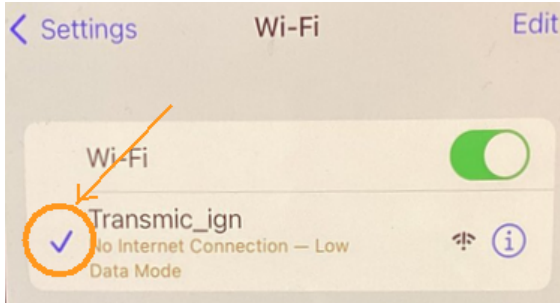

1) Disconnect Cellular data

2) Forget the "transmic_ign" SSID and connect to it again:

<https://youtu.be/yQKFOLIKlqo?si=A0CFfJYSo3uqEjml&t=18>

3) Remove interworking from the wifi configuration:

Settings > Cellular Data > Wi-Fi Calling: Off

4) Disable the automatic switch to mobile data when Wi-Fi connectivity is "poor"

Settings > Mobile Service > Wi-Fi Assist: off

<https://youtu.be/yQKFOLIKlqo?si=AaP1W3ZmdztTiKkh&t=162>

5) Disable WiFi Auto-join to your local network:

<https://youtu.be/9vM95hIBW-c?si=xnFNmgoxQUGXkSbJ&t=18>

Check your WLAN settings under:

Settings > Maintenance > Support Info > System Config > Show System Config

Ignition Timing

Assuming you want this ignition curve:

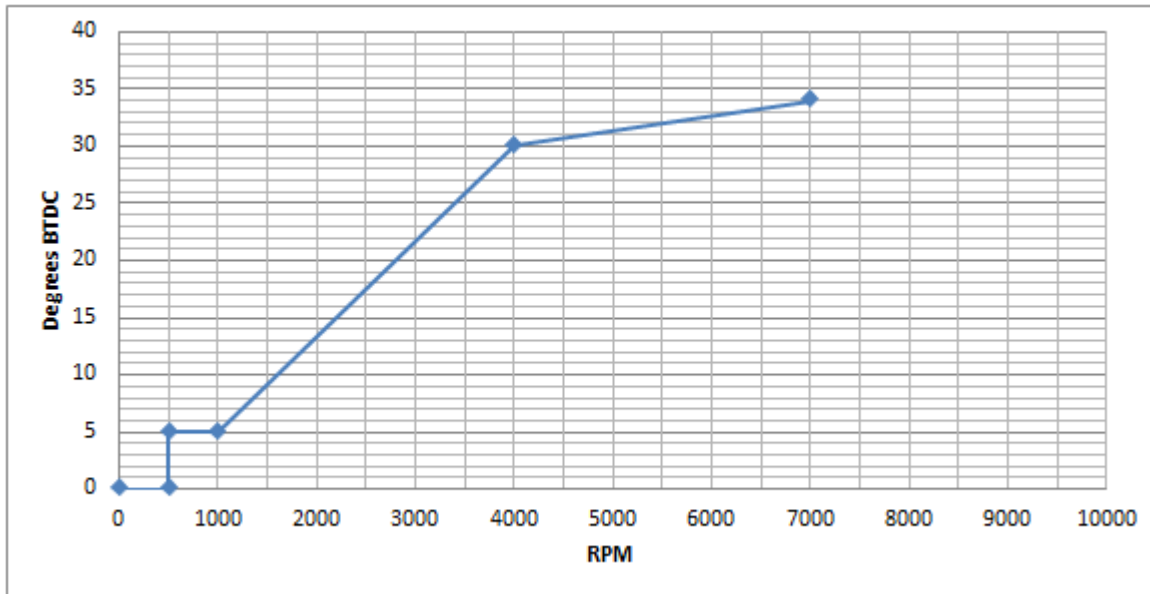

One can define the curve with 4 points but you can use up to 13 points.

(0 to 500rpm at 0° BTDC is hard coded for no kickback.)

The curve above is defined by 4 pairs of values

500 rpm	=	5°	BTDC
1000 rpm	=	5°	BTDC
4000 rpm	=	30°	BTDC
7000 rpm	=	34°	BTDC

Those 4 couples of values MUST be filled out in the form consecutively and in ascending order of RPM along with the pickup position.

Use this Windows software to draw the curve: [Interactive Graph.exe](#) with [Video](#)

Pickup Type

Default: 0

MENU	PICKUP TYPE	PICKUP POSITION
STROKES	SHAFT	CYLINDERS
ADVANCE TIMING	ADVANCE 0-500rpm	AUTO SPARK
DWELL	BYPASS	CONSOLE
MODIFY	UPDATE	

[0]

- 0: Analog Pickup Coil (VR-PN)
- 1: Analog Pickup Coil (VR-NP)
- 2: Digital Hall Effect Sensor *

Send

* option

Select the type of pickup attached to the Ignition box:

When the **LEADING** edge of the magnet passes in front of the pickup coil, a wave is produced and another wave of opposite voltage is generated when the **FALLING** edge of the magnet leaves the pickup coil. Depending on the wiring, the first pulse at Leading Edge can be positive (then negative at Falling edge), or the exact opposite.

0 = VR stands for Variable Reluctor aka pickup coil/trigger coil (Analog signal) **Positive first (PN)**

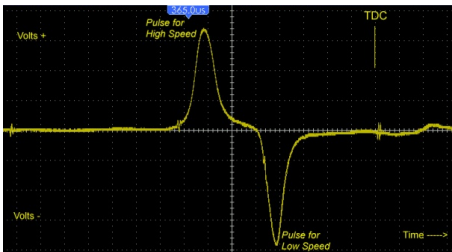

1 = Variable Reluctor (Analog signal) **Negative first (NP)**

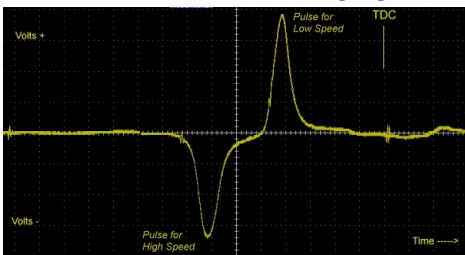

2 = Hall Effect Sensor (Digital signal)

This ignition box **works best with Positive first pickup (VR-PN)**

If the pickup is internally grounded into the stator there is no choice, the pickup output is either PN or NP
But if both pickup wires are available, then just [swap the wires](#) to change the polarity
in order to get a **Positive first signal (PN)** on connector **pin7**.

Pickup voltage

In order to be detected by the ignition, the VR pickup MUST deliver sufficient voltage.

The higher the RPM, the more voltage it must produce.

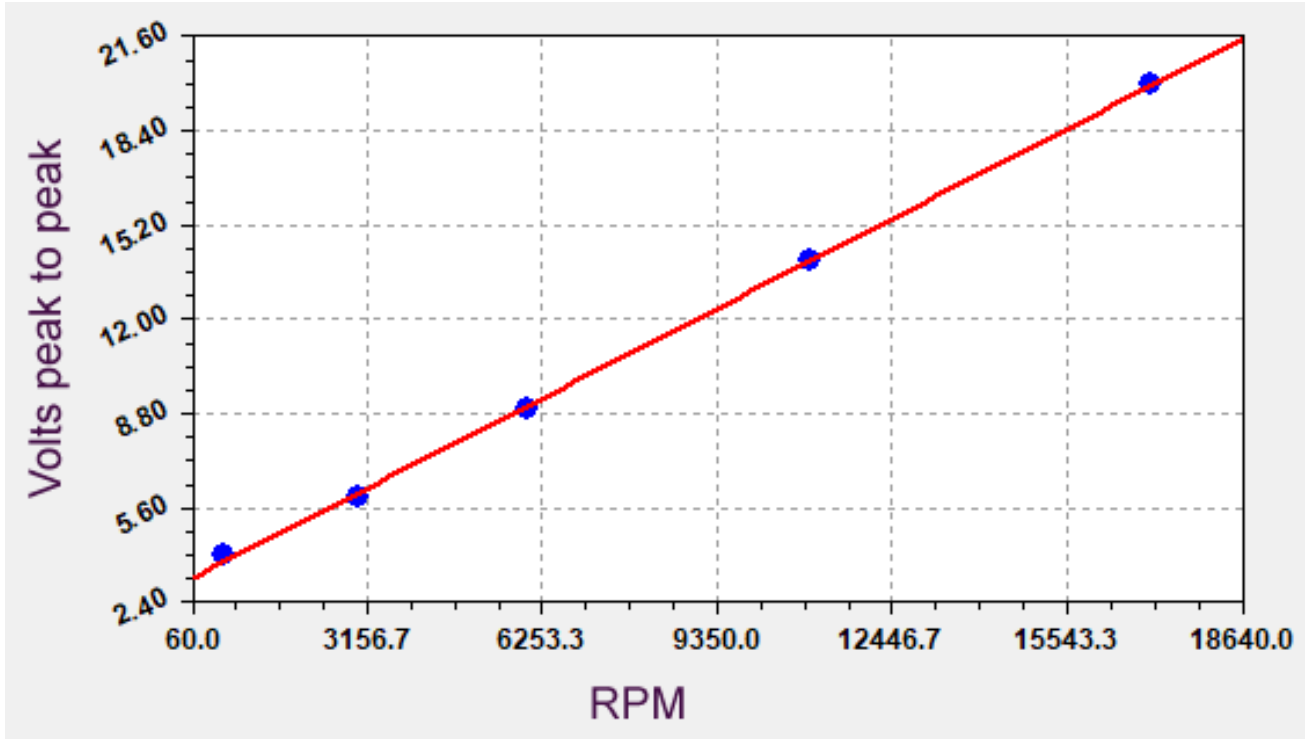

Formula :

$$\text{minimum Vpp voltage} = \text{RPM}/1000 + 3$$

Example :

At **6000rpm** the VR pickup must put out :

$$6000/1000 = 6$$

$$6 + 3 = 9\text{Vpp}$$

$$9\text{Vpp} = +4.5\text{v to } -4.5\text{v}$$

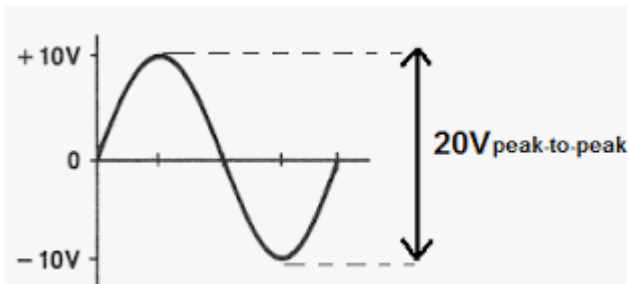

VR pickup

Analog VR pickup is connected between pin 7 and pin 8(gnd)

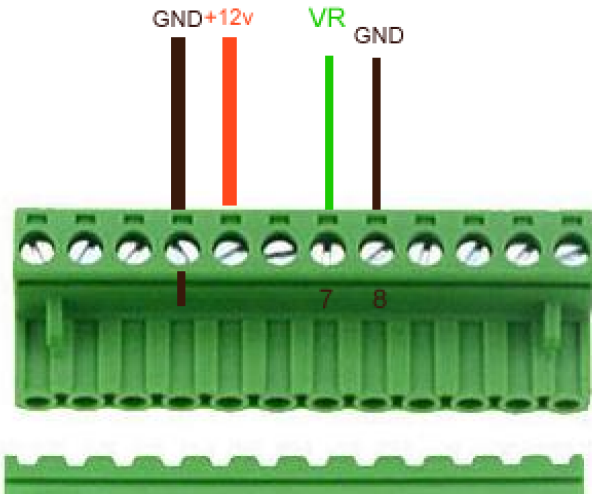

*To avoid ElectroMagnetic Interference (EMI) it's safer to connect the pickup sensor through a shielded cable.
Shield grounded on CDI side only.
Twisted pair is better.*

Hall Sensor

Digital **Hall Sensor** is connected between **pin 9** and **pin 8(gnd)**

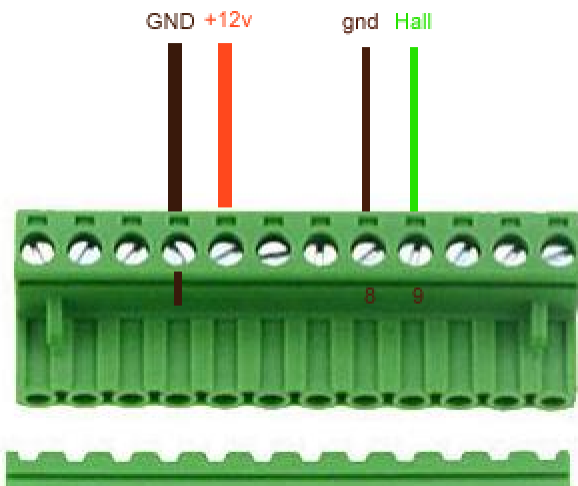

[Pickup Type](#) must be set to [2] for use of a Hall sensor.

2 types of Sensors

- Hall sensors with **open-collector** output, give a floating voltage when no magnet. They need a pull-up resistor.

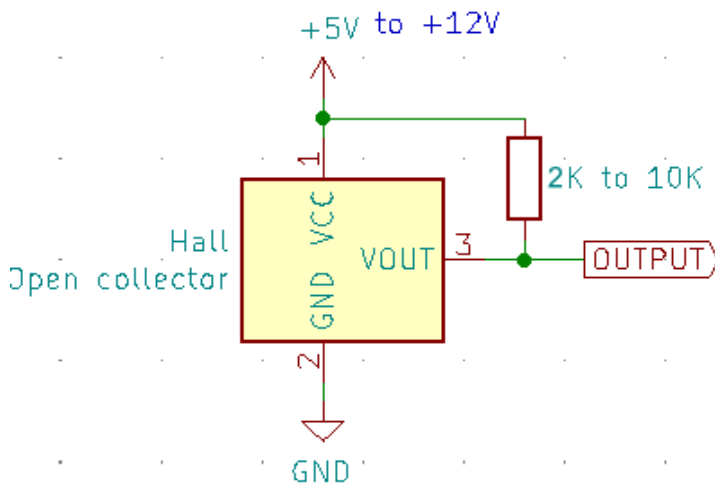

- Hall sensors with **built-in pull-up resistor** give positive voltage when no magnet.

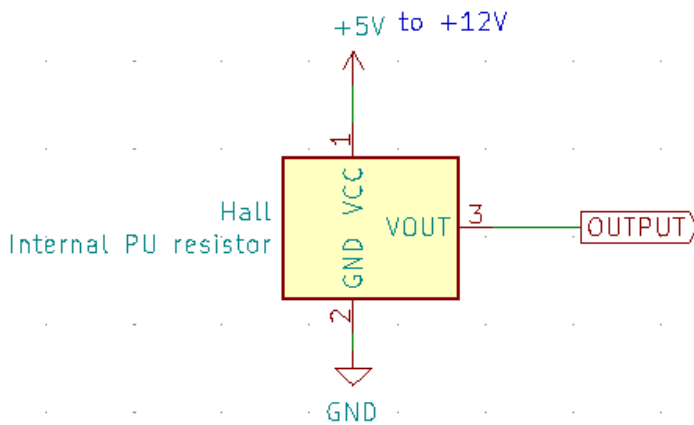

Hall sensors require a +5V to +12Vdc supply voltage. See *datasheet*

You can even connect an **Optical Sensor** as long as it puts out a **CLEAN** square signal similar to the one above.

See [Appendix 2](#) for Position

Output of a Hall sensor

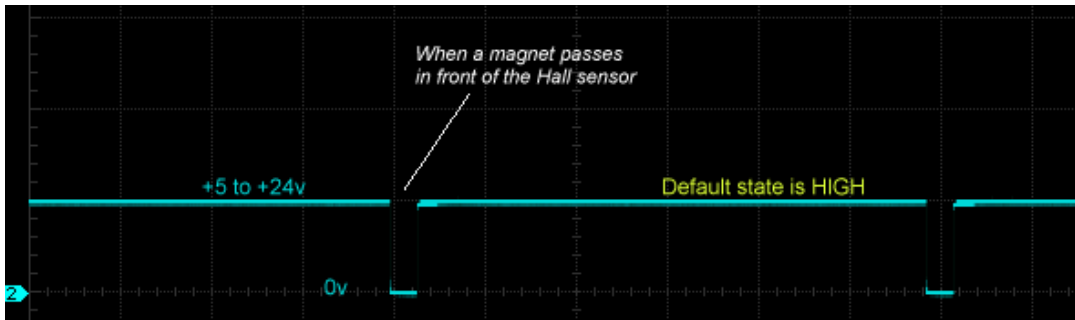

Timing

The ignition box uses the **rising edge** of the Hall sensor **signal**.



The rising edge of the signal appear when the magnet leaves the hall sensor, therefore when the hall sensor is aligned with the **falling edge of the magnet**.

You can even connect an **Optical Sensor** as long as it puts out a **CLEAN** square signal similar to the one above.

Pickup Position

Default: 50

Range of values: 1 to 360

MENU	PICKUP TYPE	PICKUP POSITION
STROKES	SHAFT	CYLINDERS
ADVANCE TIMING	ADVANCE 0-500rpm	AUTO SPARK
DWELL	BYPASS	CONSOLE
MODIFY		

[USERPOS]

BTDC

Send

- Go back to the browser and first thing first, enter the **Pickup Position** then click **Send**

Formula is: **Pickup position = Base advance + Magnet Length**

Magnet Length:



Base advance is generally 5 to 15° BTDC

See [Appendix 1,2,3](#) to find the physical position of the pickup relative to TDC.

Current value appears in blue on the form.

Strokes

Default: 2

STROKES	SHAFT	CYLINDERS
ADVANCE TIMING	ADVANCE 0-500rpm	AUTO SPARK
DWELL	BYPASS	SECURITY
CONSOLE	MODIFY	UPDATE

[2]

- 2 strokes
- 4 strokes with Wasted Spark
- 4 strokes No Wasted Spark

Send

2 strokes : One pickup pulse every rotation
4 strokes with Wasted Spark : One pickup pulse every rotation = spark at TDC + wasted spark at BDC
4 strokes No Wasted Spark: One pickup pulse every 2 rotations = spark at TDC only

4 strokes with Wasted Spark is the most common case.

Shaft

Default: 0

MENU	PICKUP TYPE	PICKUP POSITION
STROKES	SHAFT	CYLINDERS
ADVANCE TIMING	ADVANCE 0-500rpm	AUTO SPARK
DWELL	BYPASS	CONSOLE
MODIFY		

[USERSFT]

- 0: CrankShaft
- 1: CamShaft
- 2: 2pulses/rev

- Select if the pickup is placed :
 - **0**: on the **crankshaft** via the flywheel (2stk) with 1 pulse per rotation
 - **0**: on the **crankshaft** via the flywheel (4stk) with 1 pulse per rotation with wasted spark. (*one spark occurs during the compression stroke and another during the exhaust stroke.*)
 - **1**: on the **camshaft** (4stk) with 1 pulse per 2 rotations.
 - **2**: on the **crankshaft** with 2 pulses per rotation

Current value appears in blue on the form.

Advance Timing

Default: Empty

- Proceed now to enter the advance timing.

We want to setup:

500 rpm = 5° BTDC
1000 rpm = 5° BTDC
4000 rpm = 30° BTDC
7000 rpm = 34° BTDC

Enter values consecutively in ascending order of RPM !

Pair 500:5 first etc etc...

7000 being the last value (as the firmware stops reading when it meets a null value),

7000 will act as the hard rev-limiter: No more sparks at 7001 RPM !

MENU	PICKUP TYPE	PICKUP POSITION
STROKES	SHAFT	CYLINDERS
ADVANCE TIMING	ADVANCE 0-500rpm	AUTO SPARK
DWELL	BYPASS	CONSOLE
MODIFY		

Stored Values:

Timing Curve 1:

0	500
4	5
8	1000
12	5
16	3000
20	40
24	8000
28	30
32	0
36	0
40	0
44	0

Curve N°1 or N°2*

USERTIM

RPM
3000

ADV
14°

Curve
0 (0=curve N°1)

Send
* Option

RPM can be entered with a 100rpm step but RPM will be measured with **1rpm** precision.

Timing can be entered with a precision of 1° but the processor calculate all timing values between the points you entered using linear interpolation so an **accuracy of 0.1°** is done at this step.

Any timing values will be **COMPLETELY OFF IF PICKUP POSITION IS FALSE: PICKUP POSITION IS KEY**

See [Appendix 1](#) for Position

Curve N°1 is stored from addresses 0 to 100

Select curve

Default: curve N°1

If you bought the 2 curves option, then connect a switch between connector **pin 12 and ground**.

When switch is **open** (or no switch connected), **curve N°1** will be used.

If switch is **on** (*pin 12 connected to ground*) BEFORE turning on the ignition box, then **curve N°2** will be used.

You cannot change the curve while running.

MENU	PICKUP TYPE	PICKUP POSITION
STROKES	SHAFT	CYLINDERS
ADVANCE TIMING	ADVANCE 0-500rpm	AUTO SPARK
DWELL	BYPASS	CONSOLE
MODIFY		

Curve N°1 or N°2*

500 => 14

RPM

3000

ADV

14 °

Curve

1 (0=curve N°1)

Send

* Option

96	0
100	0

Timing Curve 2:

104	501
108	5
112	1001
116	8
120	3001
124	30
128	10001
132	40
136	0
140	0
144	0
148	0
152	0
156	0
160	0
164	0
168	0
172	0
176	0
180	0
184	0
188	0
192	0
196	0
200	0
204	0

Settings:

Curve N°2 is stored at addresses 104 to 204

Read

- To display the values that have been dialed in, click on the **Read** button on the **Home** page :

MENU	PICKUP TYPE	PICKUP POSITION
STROKES	SHAFT	CYLINDERS
ADVANCE TIMING	ADVANCE 0-500rpm	AUTO SPARK
DWELL	BYPASS	CONSOLE
MODIFY		

Stored Values:

Timing Curve:

0	500
4	5
8	1000
12	5
16	4000
20	30
24	7000
28	34
32	0
36	0
40	0
44	0
48	0
52	0
56	0
60	0
64	0
68	0
72	0
76	0
80	0
84	0
88	0
92	0
96	0
100	0

exit



Stored Values:

Timing Curve:

0	500
4	5
8	1000
12	5
16	4000
20	30
24	0
28	0
32	0
36	0
40	7000
44	34
48	0
52	0
56	0
60	0
64	0
68	0
72	0
76	0
80	0
84	0
88	0
92	0
96	0
100	0

exit



92	0	196	0
96	0	200	0
100	0	204	0

Settings:

212	400	Kick Speed (AC/DCCDI)
216	50	Pickup Position (*btdc)
232	0	Pickup Type (0:VR)
233	3	Dwell (TCI)
234	0	DwellType (TCI)
235	0	
236	0	Adv 0-500rpm (*atdc)
237	0	Console output (0:No)
238	0	HV Boost (DCCDI)
239	0	Shaft (0=crankshaft)
240	0	Autospark (TCI/DCCDI)
241	0	
242	0	
243	0	Bypass (TCI)
244	1	Cylinders
245	2	Strokes
248	2	Starts

All values must be **consecutive** and in **ascending order of RPM** !

Dump

Read EEPROM addresses and display them in HEX values for debug purpose.

Click on the **Dump** button on the **Menu** page :

The screenshot shows a menu page with several buttons arranged in a grid. The buttons are: MENU, PICKUP TYPE, PICKUP POSITION, STROKES, SHAFT, CYLINDERS, ADVANCE TIMING, ADVANCE 0-500rpm, AUTO SPARK, DWELL, BYPASS, CONSOLE, and MODIFY. Below these buttons is a horizontal line, and then a vertical stack of buttons: Read, Dump (highlighted with a red box), Home, Clear Timing, Clear All, and Factory Restore.

Dump EEPROM Hex Values:

0	F4	01	00	00	05	00	00	00
8	40	1F	00	00	28	00	00	00
16	34	21	00	00	28	00	00	00
24	00	00	00	00	00	00	00	00
32	00	00	00	00	00	00	00	00
40	00	00	00	00	00	00	00	00
48	00	00	00	00	00	00	00	00
56	00	00	00	00	00	00	00	00
64	00	00	00	00	00	00	00	00
72	00	00	00	00	00	00	00	00
80	00	00	00	00	00	00	00	00
88	00	00	00	00	00	00	00	00
96	00	00	00	00	00	00	00	00
104	00	00	00	00	00	00	00	00
112	00	00	00	00	00	00	00	00
120	00	00	00	00	00	00	00	00
128	00	00	00	00	00	00	00	00
136	FE	00	00	00	00	00	00	00
144	00	00	00	00	00	00	00	00
152	00	00	00	00	00	00	00	00
160	00	00	00	00	00	00	00	00
168	00	00	00	00	00	00	00	00
176	00	00	00	00	00	00	00	00
184	00	00	00	00	00	00	00	00
192	00	00	00	00	00	00	00	00
200	00	00	00	00	00	00	00	00
208	00	00	00	00	00	00	00	00
216	32	00	00	00	00	00	00	00
224	02	00	00	00	00	00	00	00
232	00	00	00	00	00	00	00	00
240	00	00	00	00	01	00	00	00

Home

Modification

Say you want to modify the advance timing for 7000rpm and set 35° instead of 34°

In [Read](#) mode above, we saw that RPM 7000 is stored at address 24 and timing for 7000rpm is at address 28.

24	7000
28	34
32	0

Since we want to modify the advance timing at line 28, we now have to enter :

Line **28**
New value **35**
then **Send**

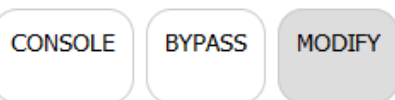

LINE
28

NEW VALUE
35

Send

Same thing to change any other values.

Remember: All timing values must be in ascending order of RPM and no blank address between timing values.

Use [Read](#) button to check that.

Add points

Say you want **to add** one advance timing of 34° @ 8000rpm

In [Read](#) mode above, we saw that last RPM 7000 is stored at address 24 and timing for 7000rpm is at address 28.

The next 2 **empty slots** available are:

24	7000
28	34
32	0
36	0
40	0

Address **32** for RPM and Address **36** for timing

We now have to enter :

Line **32**
New value **8000**
then **Send**

Line **36**
New value **34**
then **Send**

Remember: All timing values must be **consecutive** and in **ascending order of RPM** !

Use [Read](#) button to check that.

Clear points

Say you want to remove the last advance timing of 34° @ 7000rpm

In [Read](#) mode above, we saw that last RPM 7000 is stored at address 24 and timing for 7000rpm is at address 28.

24	7000
28	34
32	0
36	0
40	0

To zero out those values we now have to enter :

Line **24**
New value **0**
then **Send**

Line **28**
New value **0**
then **Send**

Remember: All timing values must be consecutive and in ascending order of RPM !

Use [Read](#) button to check that.

Stored Values:

Timing Curve:

0	500
4	5
8	1000
12	5
16	4000
20	30
24	0
28	0
32	0
36	0
40	7000
44	34
48	0
52	0
56	0
60	0
64	0
68	0
72	0
76	0
80	0
84	0
88	0
92	0
96	0
100	0



exit

Clear Timing

This button will **clear TIMING values** WITHOUT confirmation.
Pickup position, polarity, shaft, dwell etc are kept.

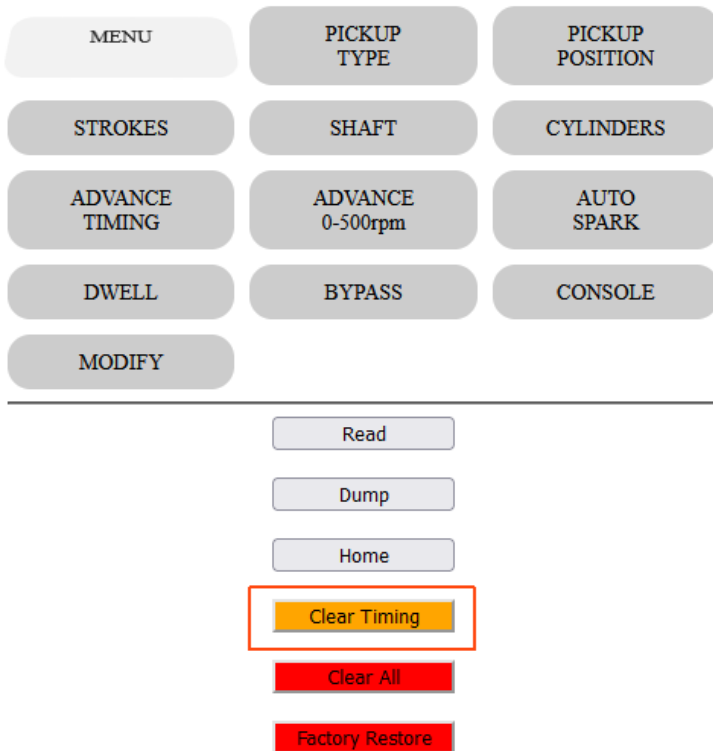

Browser shows :

Timing values cleared!

Please restart the ignition box.

This box now has no Advance Curve and cannot operate until you set timing values.

Restart the ignition box. (power off/power on)

Don't forget the Kill switch position if you want to return in Setup mode....

Clear All

This button will **clear ALL values** WITHOUT confirmation.
Timing, Pickup position, polarity, shaft, dwell etc are zeroed.

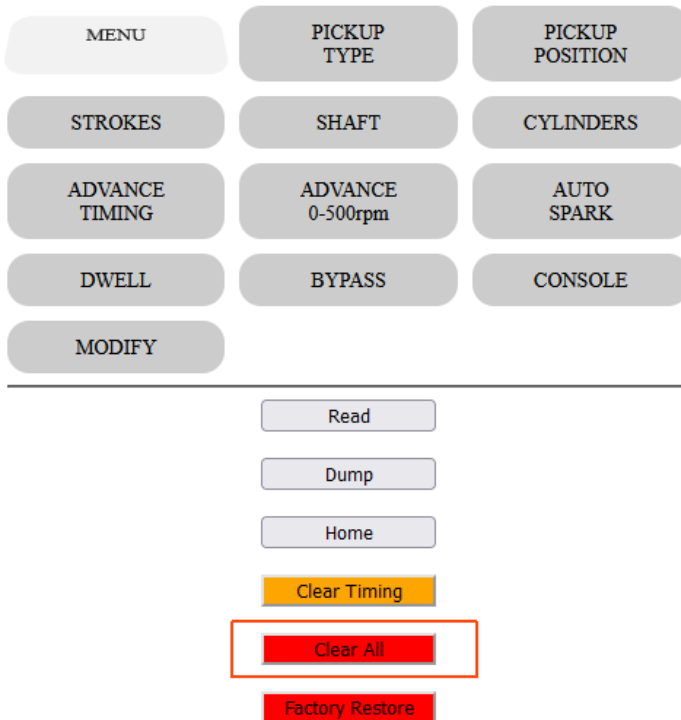

Browser shows :

EEPROM values cleared!

Please restart the ignition box.

This box is now empty and cannot operate until you set values. '

Restart the ignition box. (power off/power on)

Don't forget the Kill switch position if you want to return in Setup mode....

Factory Restore

This button will **Restore Factory Default** WITHOUT confirmation.

Timing, Pickup position, polarity, shaft, dwell etc are set to default values. (Payed Options are kept)

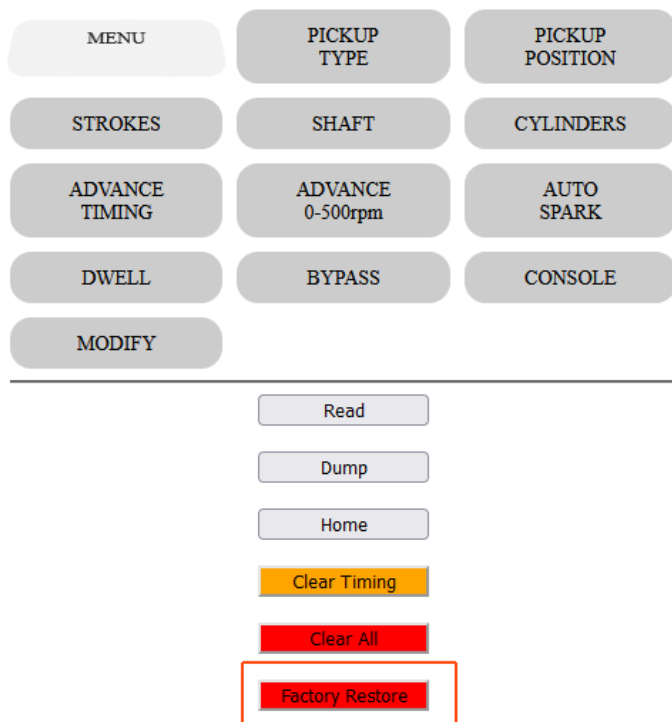

Browser shows :

Init All done!

This box now have a default Advance Curve which is not the one you need...
Tune the values before to start the engine!

Restart the ignition box. (power off/power on)

Don't forget the Kill switch position if you want to return in Setup mode....

Advanced settings

If you don't need those Extra settings, just let them to their default value.

Advance at kick start

Default: 0

Range of values: 0 to 10

For an easier Manual Kick start and to avoid kick backs, you can delay the advance between 0 to 500rpm to send the spark a few degrees **After** Top Dead Center (ATDC)

MENU	PICKUP TYPE	PICKUP POSITION
STROKES	SHAFT	CYLINDERS
ADVANCE TIMING	ADVANCE 0-500rpm	AUTO SPARK
DWELL	BYPASS	CONSOLE
MODIFY		

[0]

ATDC

Send

Current value appears in blue on the form.

Tech info:

If the measured period/rpm is less than 500rpm, the CPU uses the measured rpm (ie 320rpm) to determine when the next TDC will append during the next revolution, assuming the rpm remains constant.

If the engine speed decrease due to low inertia, the TDC calculation will be incorrect, resulting in an early spark.

To address this issue, the CPU adds an offset to the calculation, which equals the value of the "Advance 0-500" tab that the user may have set.

i.e., if the user specifies 20° ATDC, the CPU will calculate the theoretical next TDC and add 20° to the result.

If the measured rpm is over 500rpm, the CPU read the advance timing map the user has set to find which advance must be applied for this specific RPM (ie520rpm). *No user offset will be used.*

Kick Speed

Default: 800

Range of values: 100 to 1000rpm

For an easier Manual Kick start and to avoid kick backs, you can select what will be the RPM of the very first engine rotation when it is kick started.

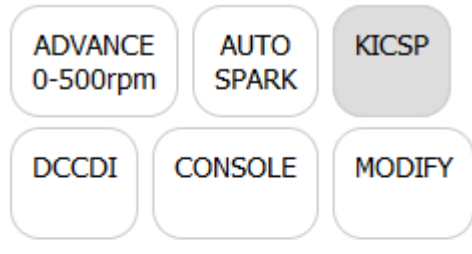

[800]

Kick Speed

 rpm

Send

Current value appears in blue on the form.

Tech info:

When a trigger signal comes (pickup or hall), the CPU measures the time between this pulse and the preceding one to determine the period, and hence the rpm.

At the very first pulse only, as there is no previous one, the period is unknown.

The CPU then uses the "kick speed" rpm (default 400rpm) or any other value the user may have specify.

The "kick speed" value will not be used for the following pulses because the period will be calculated based on two consecutive trigger pulses.

If there is more than 1sec between 2 pickup pulses, "kick speed" setting will be applied again for the next first pulse.

Console

Default: Off

Enable the Console output:

- Turn the ignition box in [Setup Mode](#)

- Go to "**CONSOLE**", check "1" to enable the console output, press Send

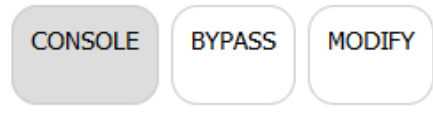

[0]

- 0: Off
- 1: On

Send

Current value appears in blue on the form.

- Power **off** the ignition box

- **Disconnect** the **Kill** wire from ground

1) **Power on** the ignition box, it goes in "**Run Mode**"

2) The **LED** flashes once if curve N°1 is selected or flashes twice for curve N°2

4) The ignition box also creates a **WiFi AP** (*Access Point*)

5) On your phone, laptop, PC, whatever, go to the **Wifi setting** and search for a new SSID called **Transmic_ign**

You can see available SSID with a Wifi Analyzer as [NetSpot for Android](#) or [Wifi-Analyzer for W10](#)

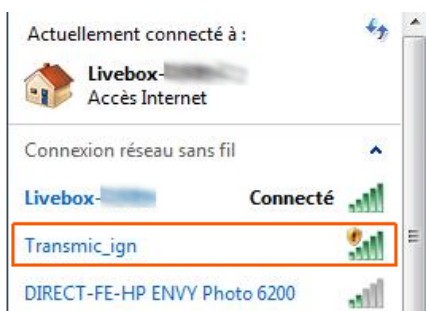

6) **Connect** to it. Password is required: it's "**password**"

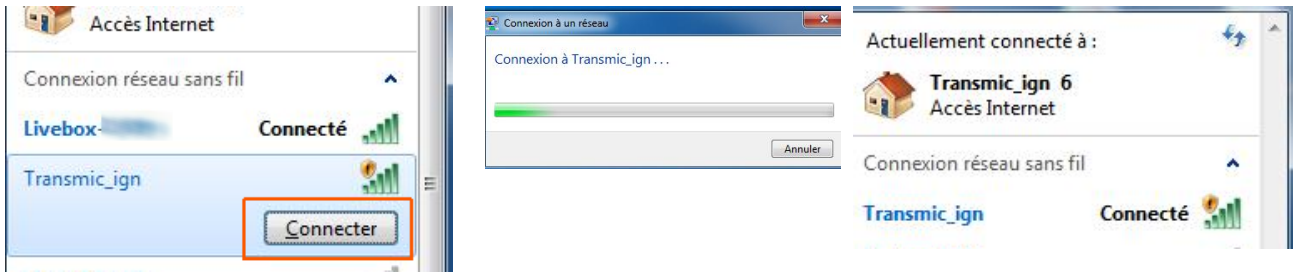

7) **Start** the engine

8) Once your device is connected to the AP, open up a **browser** and type in the address bar:

<http://192.168.4.1/console>

9) After a few seconds, the browser should display both the **RPM and the advance timing** in degrees BTDC followed by 2 bargraphs

RPM vs ADV

3360

39.29



Display appears ONLY when the engine is running.

Because of the impact on Ignition box performance, please use it for debug only and disable this function when you are done with it!

Troubleshooting

Console URL is **http://** NOT **https://** but some browsers as Chrome automatically switch to **https://**

Workarounds

- Use Firefox. Close all Firefox windows than relaunch it.
- Use a lightweight, portable browser as [QtWeb](#)
- In Chrome, disable **HSTS** (*HTTP Strict Transport Security*) that forces to open websites in HTTPS:
 - Write **chrome://net-internals/#hsts** in the address bar.
 - Scroll down the page to :

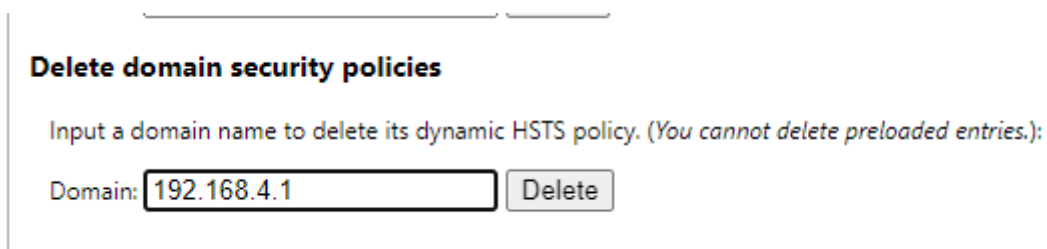

- add **192.168.4.1** and hit **Delete** to disable Force https for this particular website.

Running Mode

- 1) **Disconnect** the **Kill** wire from ground if you previously went into [Setup Mode](#)
- 2) **Power on** the ignition box, it goes in "**Run Mode**"
- 3) The **LED** flashes one time.
- 4) Start the engine. The LED **blinks** in sync **with RPM**.
- 5) When the engine runs, if **Kill** wire is connected **to ground** THEN it **stops** the engine.

*/\ For XT550-XT600 only: Kill the engine with the Kill switch BEFORE shutting down the +12v.
(As it's a software kill, the processor must be powered on to be able to kill the engine!)*

Appendix 1

Case of Variable Reluctor aka VR pickup/pickup coil/trigger coil

(For Hall sensor, read [Appendix2](#))

Find the physical position of the analog **pickup** relative to Top Dead Center.

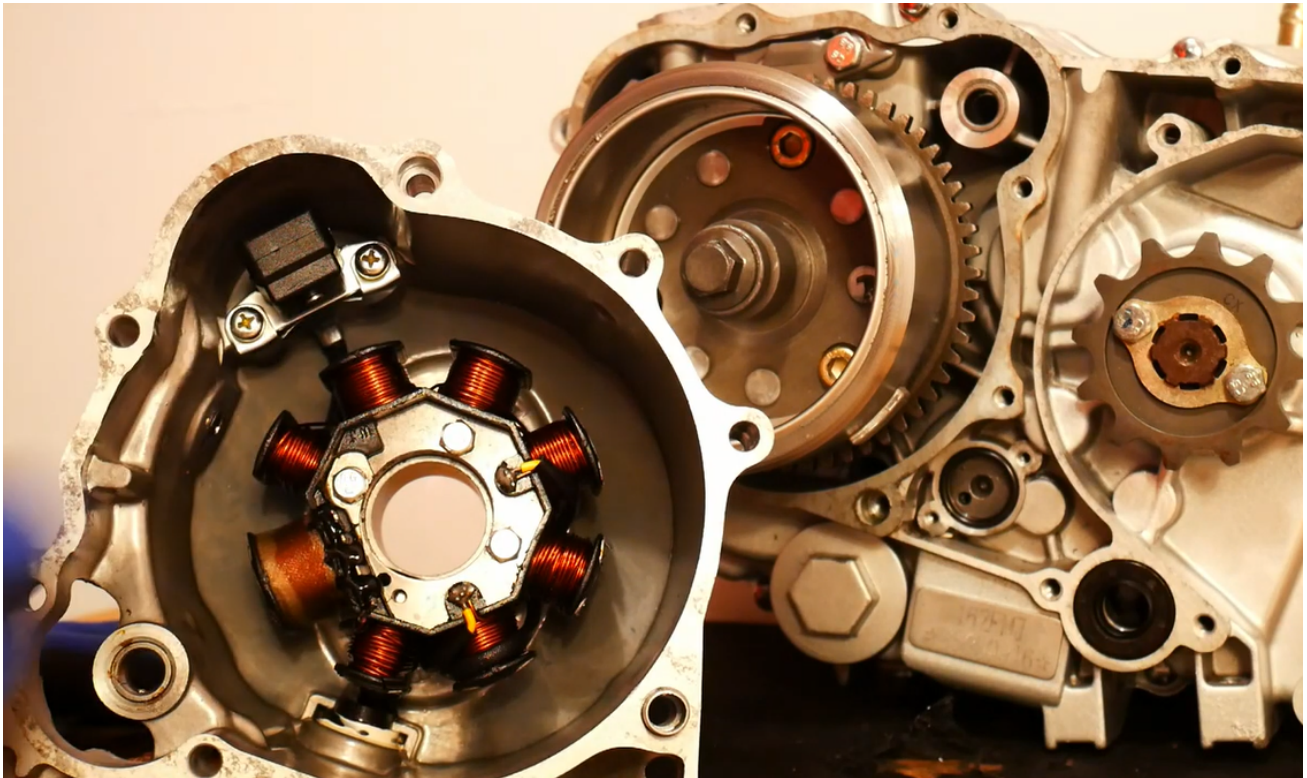

In this example below the pickup/sensor is set at 39° BTDC

Method 1:

- First align the pickup with the rising edge of the bar.
(Pay attention to direction of rotation of the crankshaft: CW or CCW)
- Measure the angle between the TDC mark on the casing and the TDC mark on the rotor

Method 2:

- Remove the sparkplug, rotate the engine to put the piston at TDC
(If TDC marks on casing and rotor exist, then they should be aligned.)
- Measure the angle between the pickup and the rising edge of the bar.
(Pay attention to direction of rotation of the crankshaft: CW or CCW)

Method N°1

Pickup aligned with rising edge

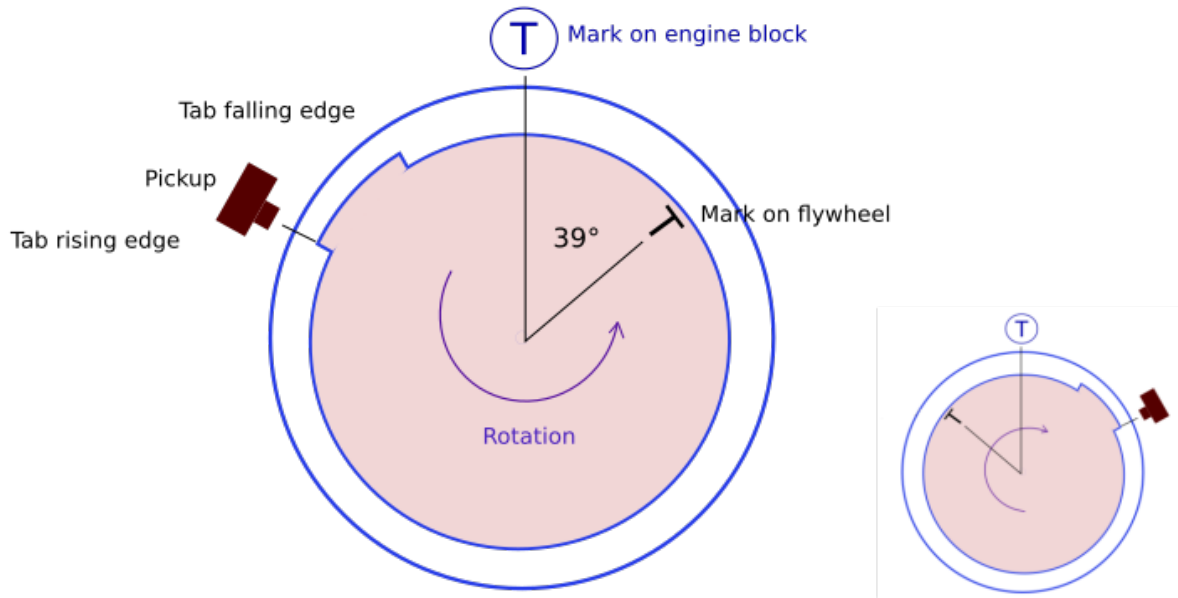

Method N°2

Engine at TDC

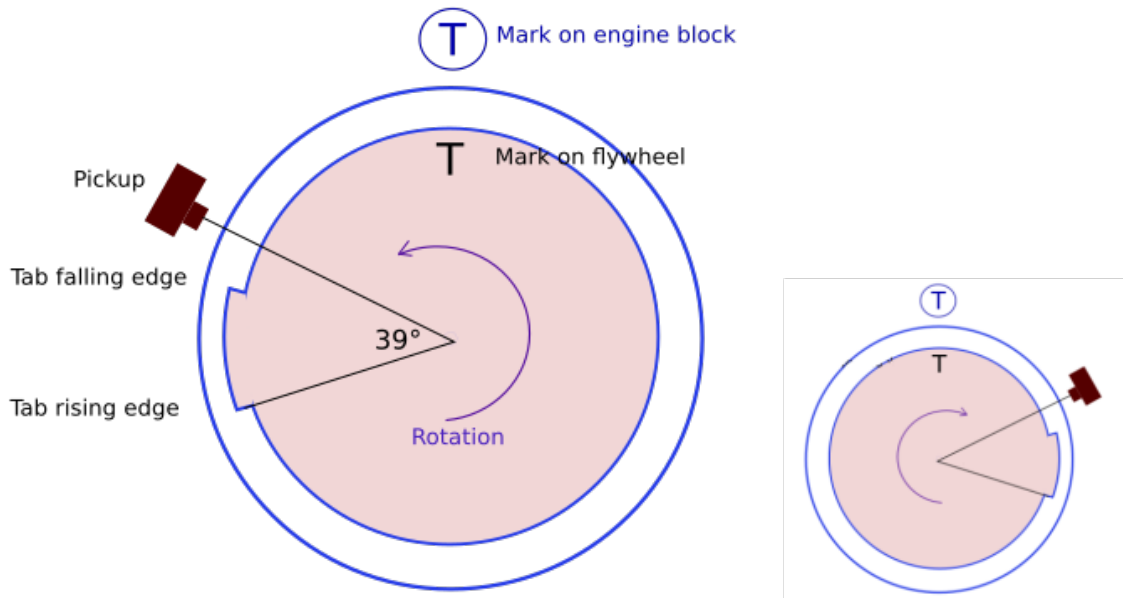

Leading|Rising edge generate pulse for high revs
Trailing|Falling edge generate pulse for idle.

calageTDC_pickup_2methods.svg

This view above represents the respective positions of the rotor and the pickup as we would see them if the engine cover were transparent.

Read timing from flywheel: <https://transmic.fr/2021/09/23/read-timing-from-flywheel/>

Appendix 2

Case of Hall Effect Sensor

(For VR pickup/analog pickup read [Appendix1](#))

Find the physical position of the digital **Hall Sensor** relative to Top Dead Center.

In the example below the sensor is set at 39° BTDC

Method N°1

Hall sensor aligned with falling edge

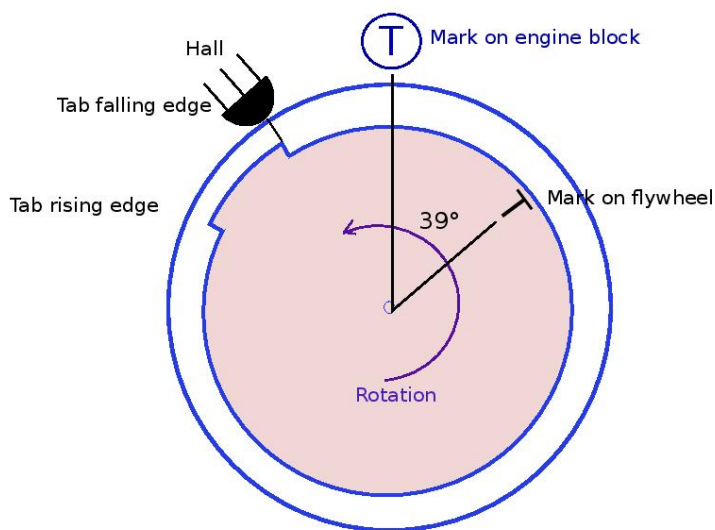

Method N°2

Engine at TDC

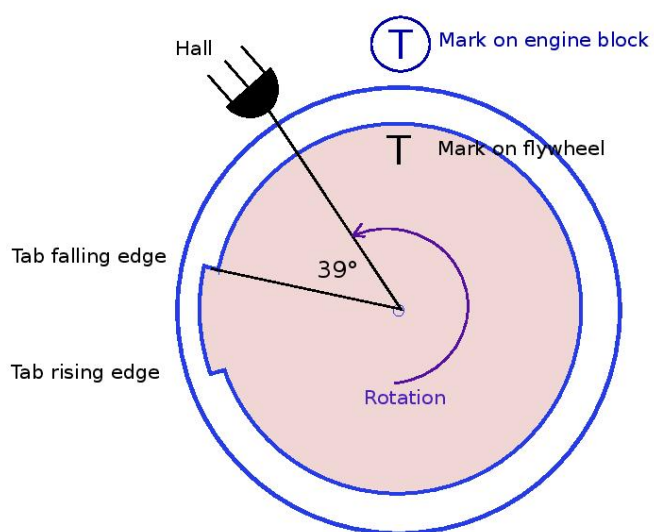

Appendix 3

A) Remove the sparkplug, find the TDC position with a *dial indicator gauge* or a *caliper rule*:



B) Align the pickup with the beginning of the magnet on the rotor and measure the travel of the piston with the caliper rule:



C) Use an online timing calculator to convert millimeters into degrees:

<https://lambretta-images.com/tuningh/port-timing-calculators/degrees-to-mm-timing-calculator/>

or

<http://www.ajcshop.fr/Calculettes/html/calculette-convertisseur-allumage.htm>

ie:

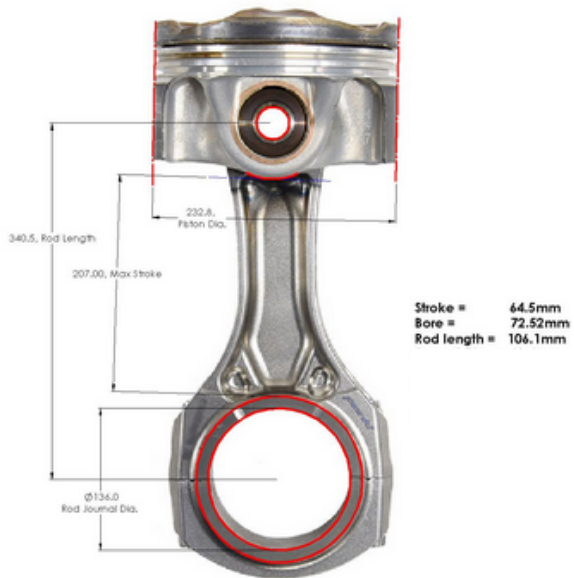

=>

1	->	64.5	Course en mm
2	->	106.1	Longueur de bielle (entraxe) en mm
3	->		Diamètre (D) du volant en mm (uniquement)
4	->	0.67	Avance en mm
Calculer		10.25	Avance en degrés (angle α) (renseigner 1, 2, 4) <u>Le résultat est en ° et centièmes de °</u>

Appendix 4

Tries and errors and Timing Lamp



If there is no mark on the flywheel, a possible way is as follows:

Method:

Remove the spark plug, insert a gauge in the sparkplug hole.
Turn the flywheel until the piston is at TDC. Remove the gauge.

Draw 2 marks opposite each other on the flywheel and on the engine case. It's the TDC mark.

Print a *Timing Tape* from <https://www.blocklayer.com/timing-tape>
Align the 0 mark to the new TDC mark and stick the tape on the flywheel.

Set the ignition box with a pickup position of say 30° BTDC

Set the ignition box with a SAFE and FLAT timing curve at a static advance (ie : 10° BTDC from 500 to 4000rpm)

Put back the sparkplug and start the engine if possible
Otherwise plug the sparkplug in it's cap, tied the plug to the frame to have sparks, then rotate the engine with a drill machine (the faster the better).

With a timing lamp, take note where on the timing tape the spark appears.

Take note how much "off" is the timing.

Examples :

If the timing lamp shows 15° BTDC (instead of 10°) that mean the "*Pickup Position*" is off by 5° (15°-10°).

The pickup position is the off by 5°. Increase the "*Pickup Position*" by 5. Real position is not 30° but $30° + 5° = 35°$

Set the ignition box with a pickup position of 35° BTDC

Using the timing lamp, check that the timing is now read at 10°

Make small adjustment to the pkp position if necessary.

If the timing lamp shows 5° BTDC (instead of 10°) that mean the "*Pickup Position*" is off by -5° (5°-10°).

The pickup position is the off by -5°. Lower the "*Pickup Position*" by 5. Real position is not 30° but $30° - 5° = 25°$

Set the ignition box with a pickup position of 25° BTDC

Using the timing lamp, check that the timing is now read at 10°

Make small adjustment to the pkp position if necessary.

In one word:

If the Timing Lamp measure MORE advance than what is set in the user interface then INCREASE the "*Pickup position*"

If the Timing Lamp measure LESS advance than what is set in the user interface then LOWER the "*Pickup position*"