

## Summary

Connector.....	2
Wiring.....	4
Setup Mode.....	6
Troubleshooting.....	7
Advance curves.....	10
Security.....	12

## Connector

XT125-400



- |           |        |  |
|-----------|--------|--|
| <b>1</b>  | output | To ignition coil                             |
| <b>2</b>  | input  | High Voltage from Charging Coil (Red wire)   |
| <b>3</b>  | input  | High Voltage from Charging Coil (Braun wire) |
| <b>4</b>  | input  | <b>Ground frame (=minus from battery)</b>    |
| <b>5</b>  | input  | <b>+12Vdc from battery</b>                   |
| <b>6</b>  | input  | Kill switch                                  |
| <b>7</b>  | input  | Pickup (White wire)                          |
| <b>8</b>  | input  | Pickup Ground (Black wire)                   |
| <b>9</b>  | input  | Security                                     |
| <b>10</b> |        | <i>not connected</i>                         |
| <b>11</b> | output | Tachometer                                   |
| <b>12</b> | input  | SELECT switch for Setup                      |

## XT550-600



- |           |        |  |
|-----------|--------|--|
| <b>1</b>  | output | To ignition coil                             |
| <b>2</b>  | input  | High Voltage from Charging Coil (Red wire)   |
| <b>3</b>  | input  | High Voltage from Charging Coil (Braun wire) |
| <b>4</b>  | input  | <b>Ground frame (=minus from battery)</b>    |
| <b>5</b>  | input  | <b>+12Vdc from battery</b>                   |
| <b>6</b>  | input  | Kill switch                                  |
| <b>7</b>  | input  | Pickup 36° for High Speed (Red/White wire)   |
| <b>8</b>  | input  | Pickup Ground - Center Tap (Green wire)      |
| <b>9</b>  | input  | Security                                     |
| <b>10</b> | input  | Pickup 12° for Low Speed (Green/White wire)  |
| <b>11</b> | output | Tachometer                                   |
| <b>12</b> | input  | SELECT switch for Setup                      |

# Wiring

XT125-400:

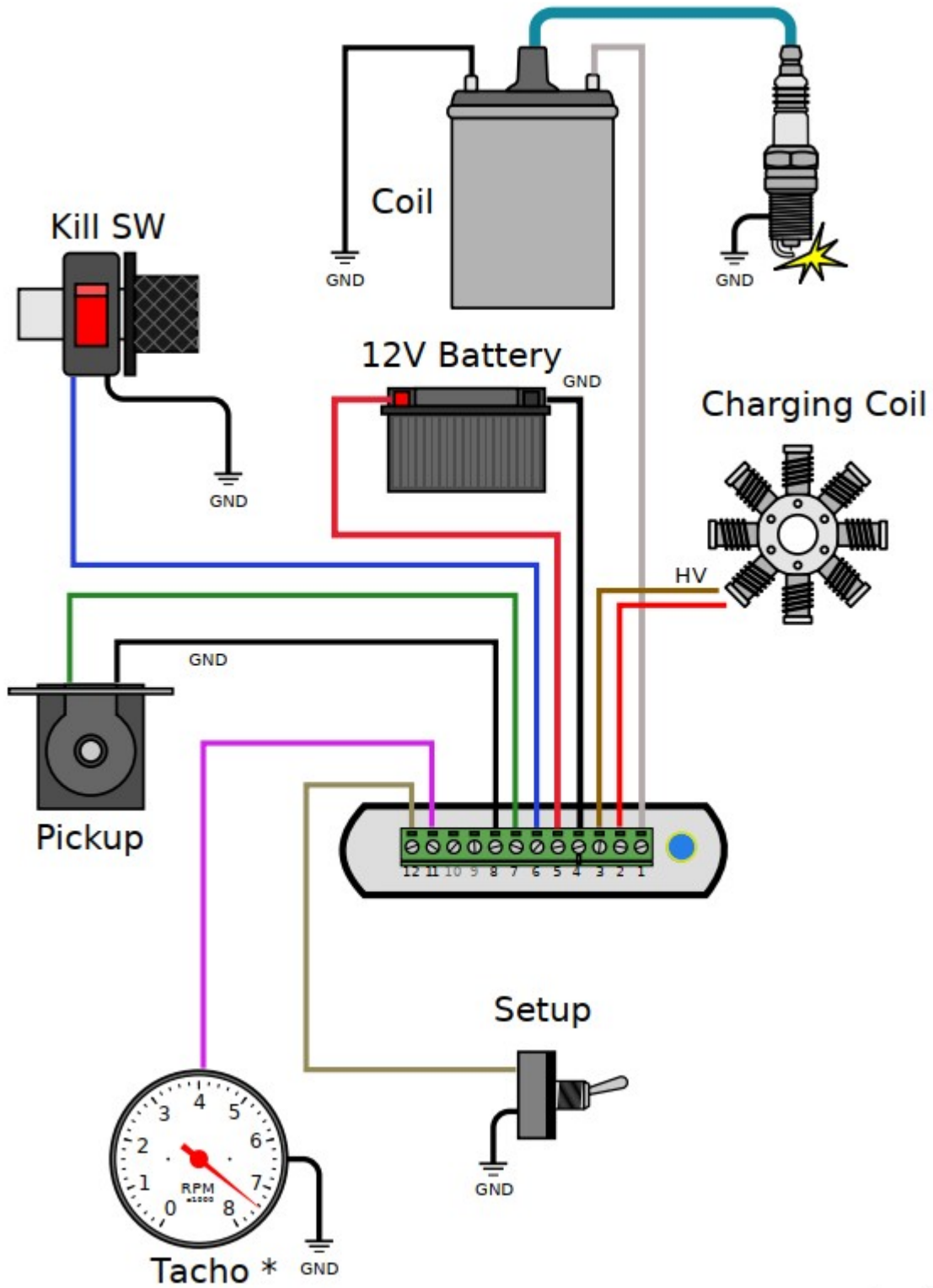

\* optional

XT550-600:

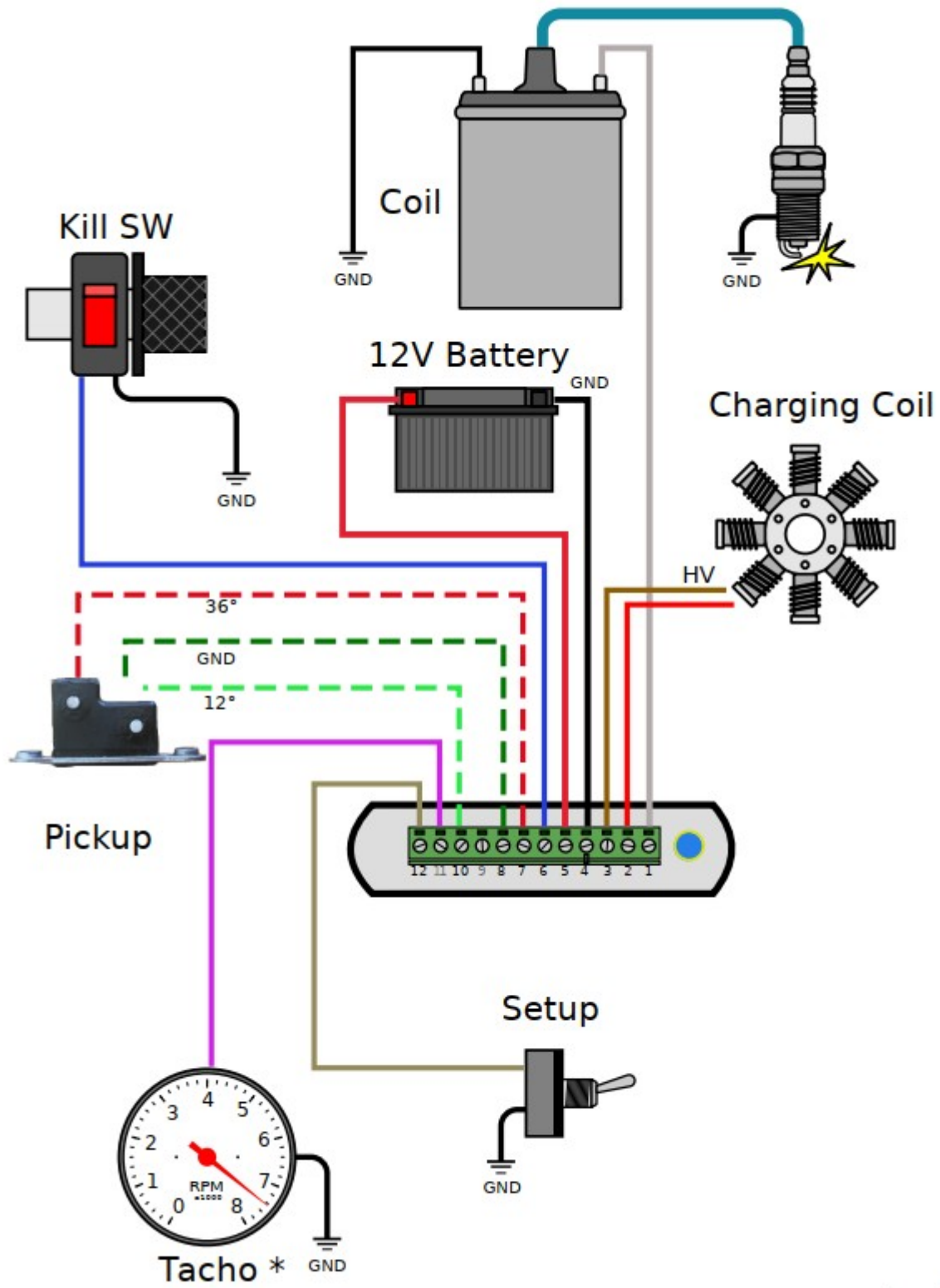

\* optional

## Setup Mode

- 1) Turn the **SELECT Switch ON** (*connector pin 12 connected to ground*) **PRIOR** to power on the ignition box.
- 2) **Power on** the ignition box with a 12v battery.  
When the ignition box detects that the Select switch is already grounded, it turns into SETUP Mode.
- 3) The ignition box starts a **WiFi AP** (*Access Point*)
- 4) On your phone, laptop, PC, whatever, go to the **Wifi setting** and search for a new SSID called **Transmic\_ign**

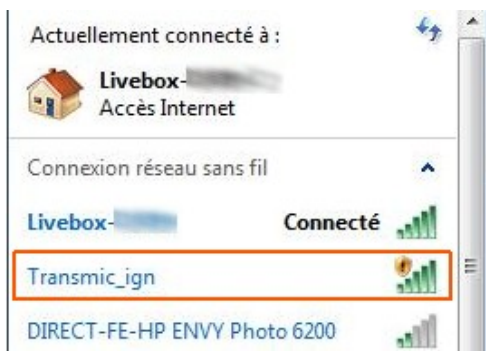

- 6) **Connect** to it. (If a password is asked, use "*password*")

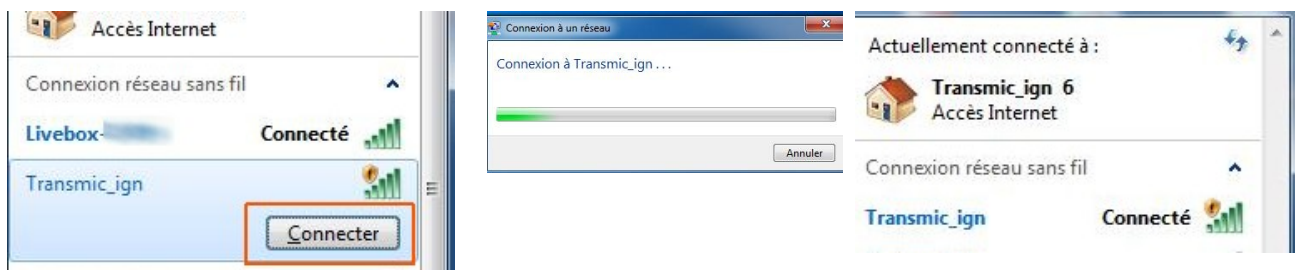

- 8) Once your device is connected to the AP, open up a **browser** and head over to <http://192.168.4.1/> (**http not https !**)

- 9) Once connected your browser should display:

**TRANSMIC.FR**

<MODEL> <VERSION>

You are now connected  
to your ignition box.

Options: 5  
Serial: 2301 ©

- 10) Turn the **SELECT Switch OFF** for Running mode.

## Troubleshooting

### No WiFi Access Point appears:

- While the ignition is powered by +12v battery, measure the voltage between ground (screw N°4) and Select (screw N°12): It should be around +3Vdc

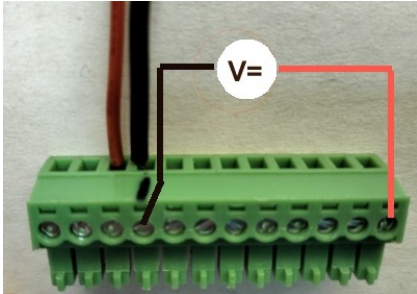

- if not, then check that the 12pins connector is FULLY inserted and there is nothing preventing the male connector from fully engaging.

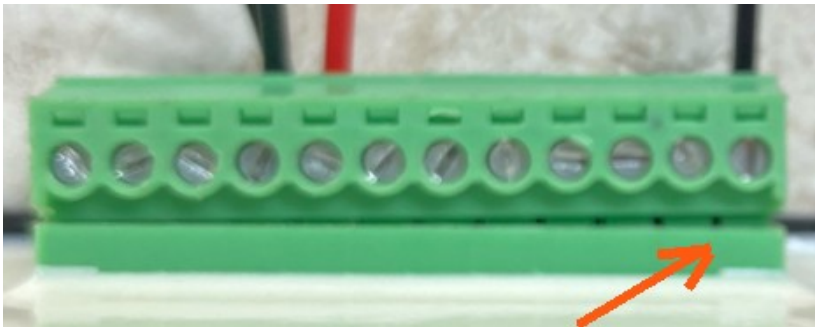

- You can see available SSID with a WiFi Analyzer as [NetSpot for Android](#) or [Wifi-Analyzer for W10](#)

- Reboot the ignition box. (Power off/power up)

## WiFi Access Point appears:

- Connect to the WiFi AP and test the network connection from your laptop to the ignition box:

Open a command Prompt:

Type "*cmd*" into the address bar of File Explorer and hit Enter or Press Windows+R to open "Run" box. Type "*cmd*" and then click "OK"

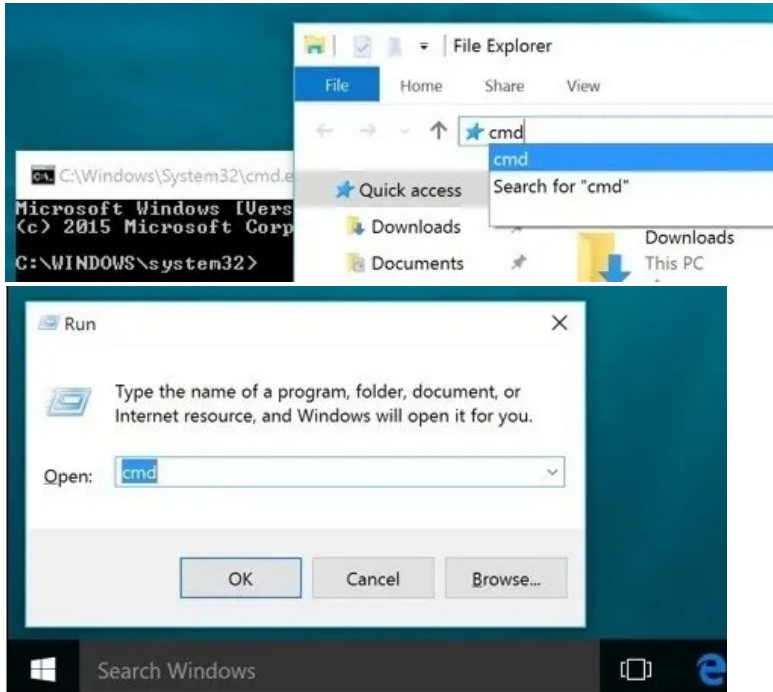

ping the ignition box, it should replies:

```
C:\>ping 192.168.4.1
```

Pinging 192.168.4.1 with 32 bytes of data :

```
Reply from 192.168.1.1 : bytes=32 time<1ms TTL=64
```

```
Reply from 192.168.1.1 : bytes=32 time<1ms TTL=64
```

```
Reply from 192.168.1.1 : bytes=32 time<1ms TTL=64
```

## Clear DNS cache

Windows:	in MsDos console:	<code>C:\&gt;ipconfig /flushdns</code>
MacOS:	in Terminal :	<code>sudo dscacheutil -flushcache</code>
Linux:	in Terminal:	<code>sudo systemd-resolve --flush-caches</code>



## Troubleshooting display

- Ignore any browser message saying it is not connected to internet:



Indeed, it is connected ONLY to the Ignition box, not to the web.  
(It's impossible to reach Google and the ignition box at the same time)

Console URL is **http://** NOT **https://** but some browsers like Chrome automatically switch to secure **https://**

- Use Firefox. Close all Firefox windows than relaunch it.
- or in Chrome, disable **HSTS** (*HTTP Strict Transport Security*) that forces to open websites in HTTPS:
  - Write **chrome://net-internals/#hsts** in the address bar.
  - Scroll down the page to :

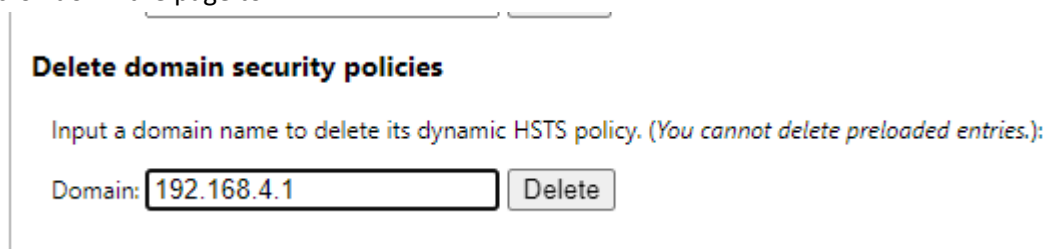

- add **192.168.4.1** and hit **Delete** to disable *Force https* for this particular website.

## Advance curves

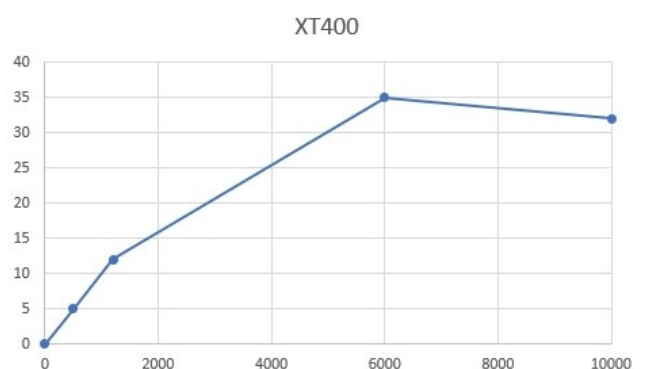
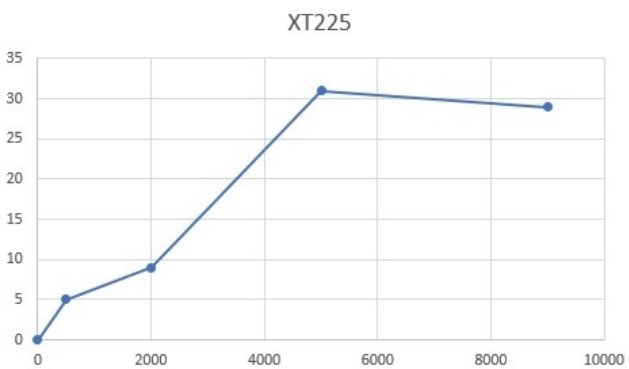
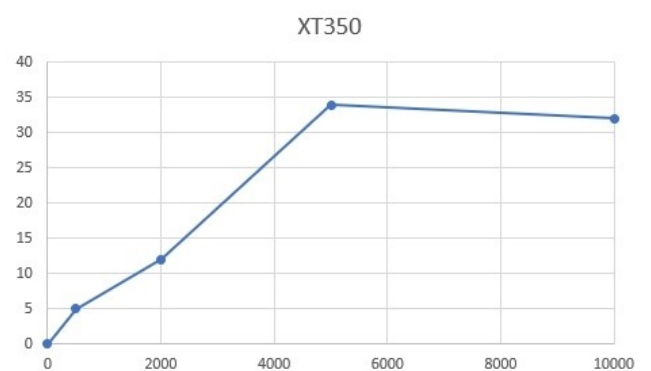
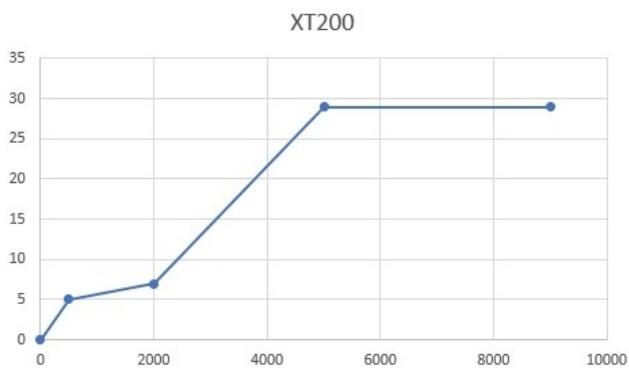
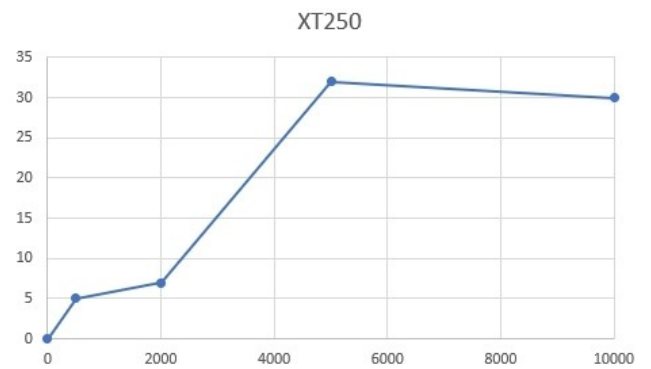
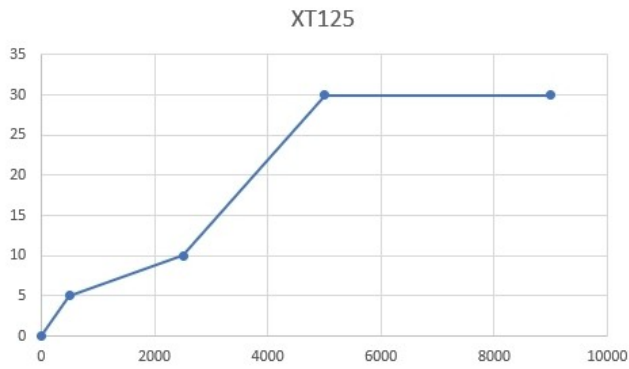

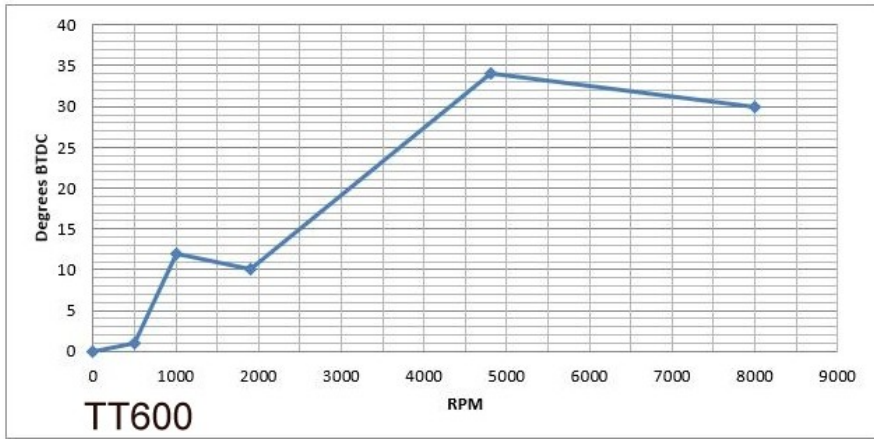
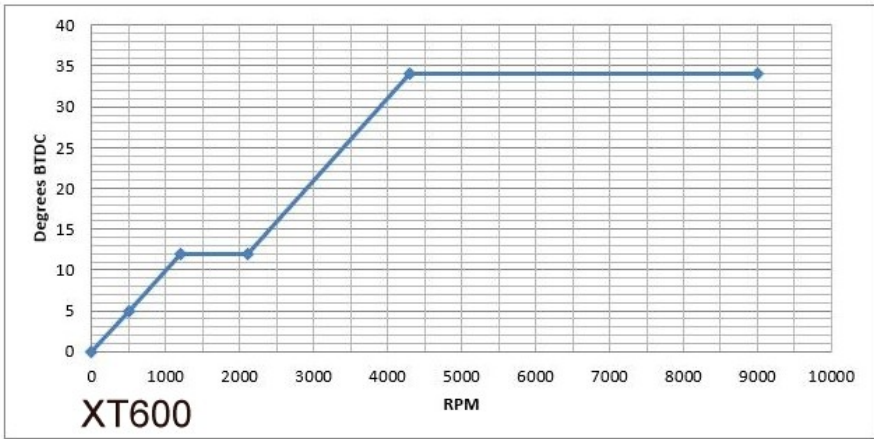
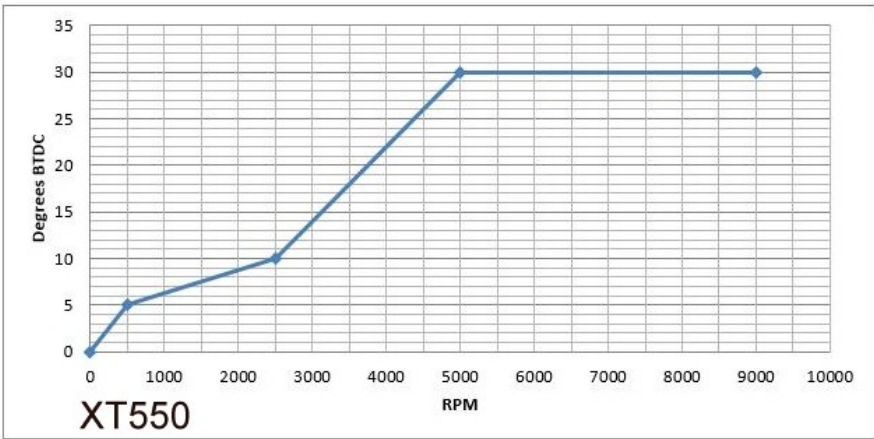

# Security

Default: 0

Range of values: 0 to 2

**Pin 9** is a security input for Neutral, Clutch or SideStand switches.

It can be configured in 3 ways:

- 0 = unused                      No security. *Pin9 is not connected*
- 1 = gnd2run                  pin9 MUST be grounded in order to run the ignition.
- 2 = gnd2kill                 pin9 kill the ignition when grounded.

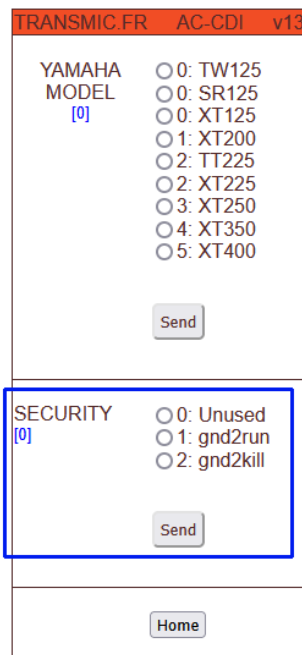

To use more then one security, use diodes to make a "OR" gate:

